

442210

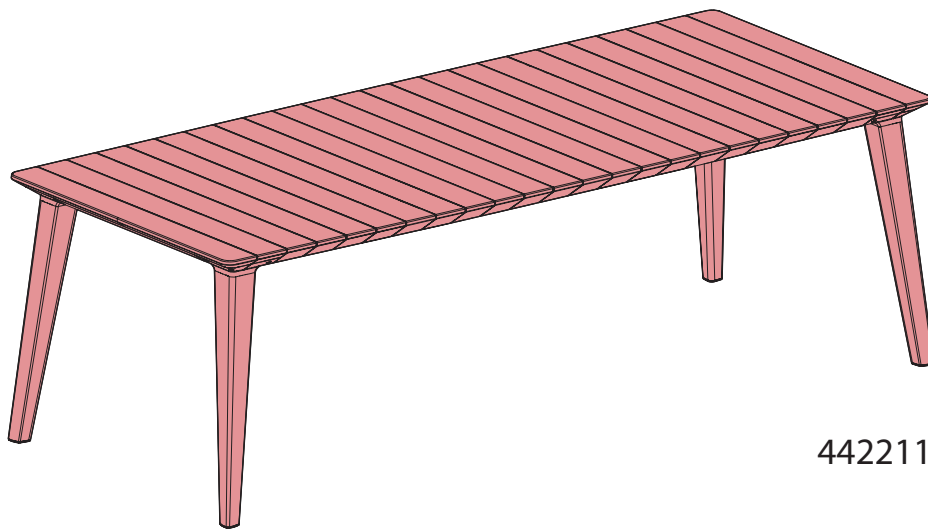

442211

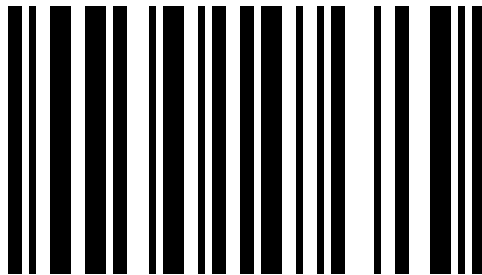

582521



EN 581

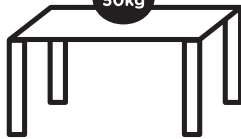
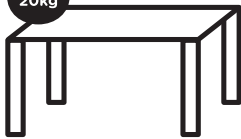
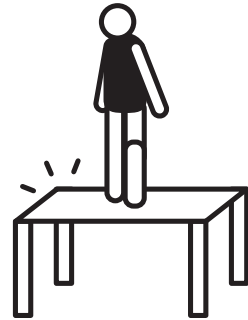
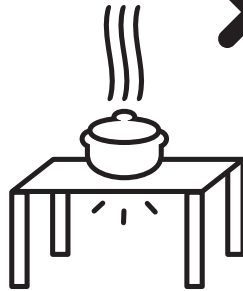
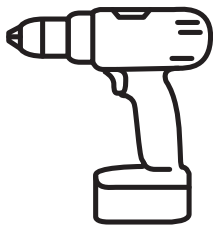
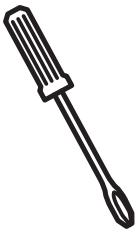
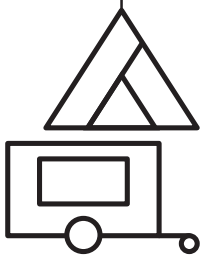

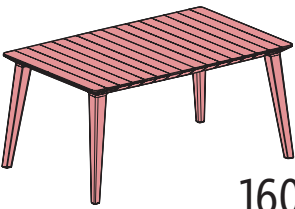
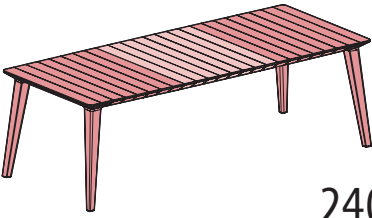
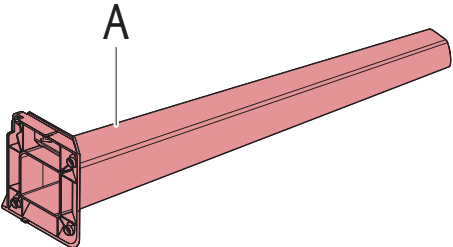
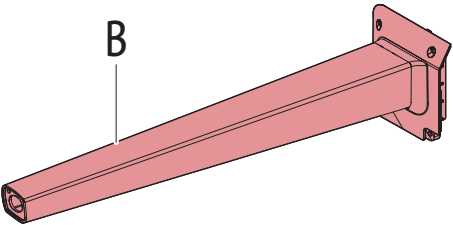
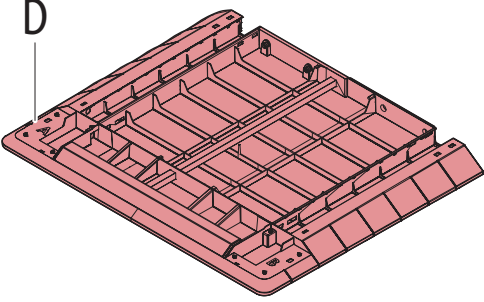
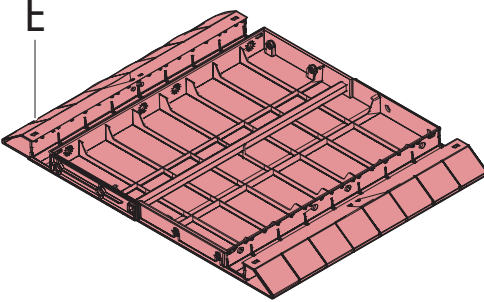
	 <p>160</p>	 <p>240</p>
 <p>A</p>	<p>2x</p>	<p>2x</p>
 <p>B</p>	<p>2x</p>	<p>2x</p>
 <p>D</p>	<p>2x</p>	<p>2x</p>
 <p>E</p>	<p>-</p>	<p>1x</p>

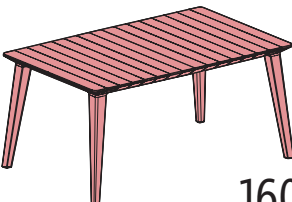
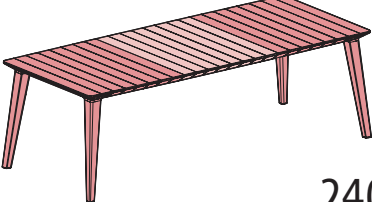
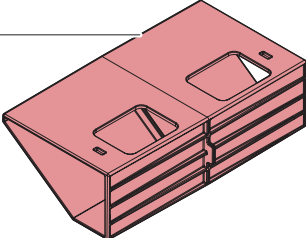
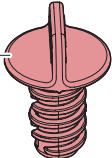
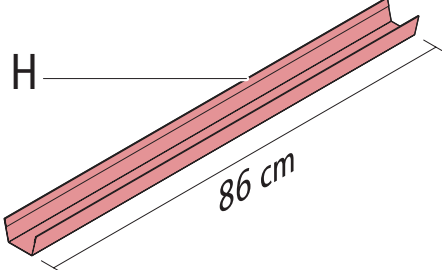
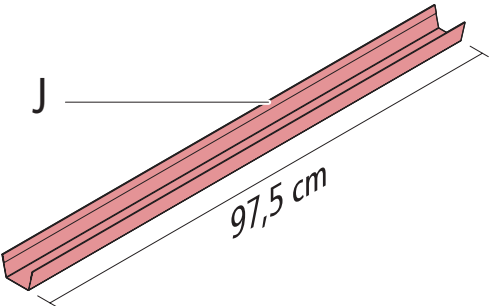
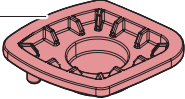
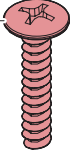
	 160	 240
<p>F</p> 	2x	4x
<p>G</p> 	4x	8x
<p>H</p>  86 cm	2x	4x
<p>J</p>  97,5 cm	-	2x
<p>K</p> 	4x	4x
<p>L</p> 	16x	16x

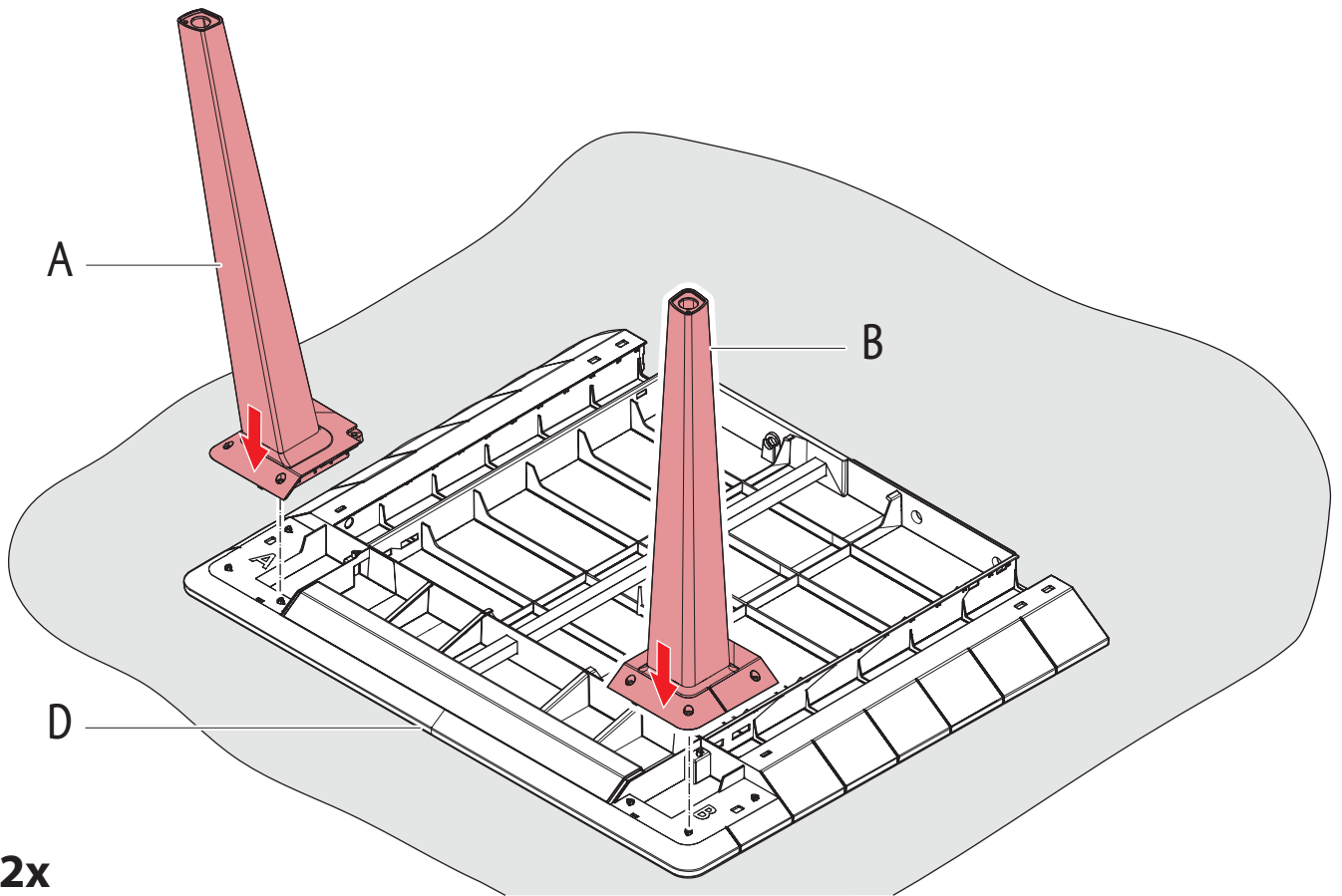

1

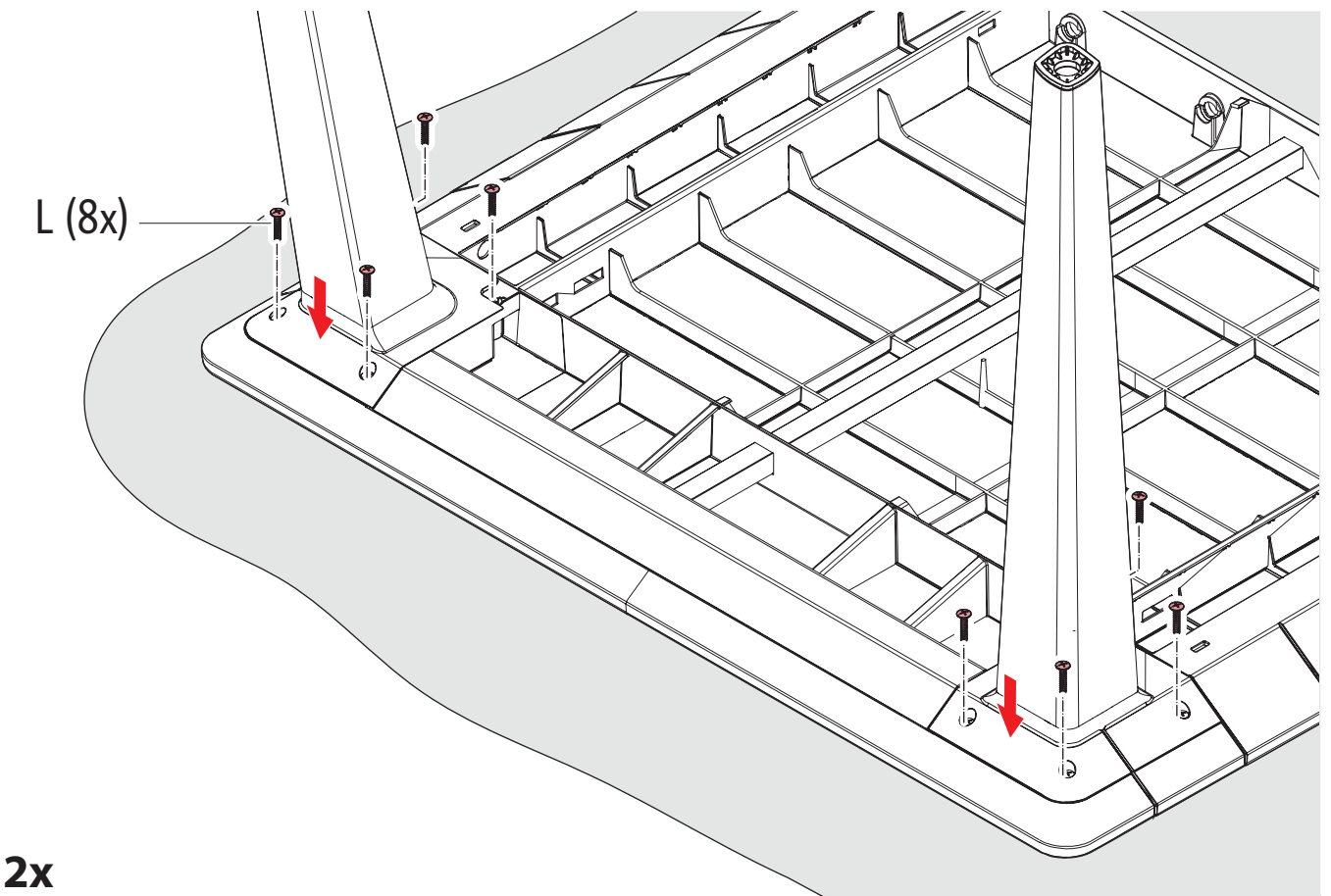

2

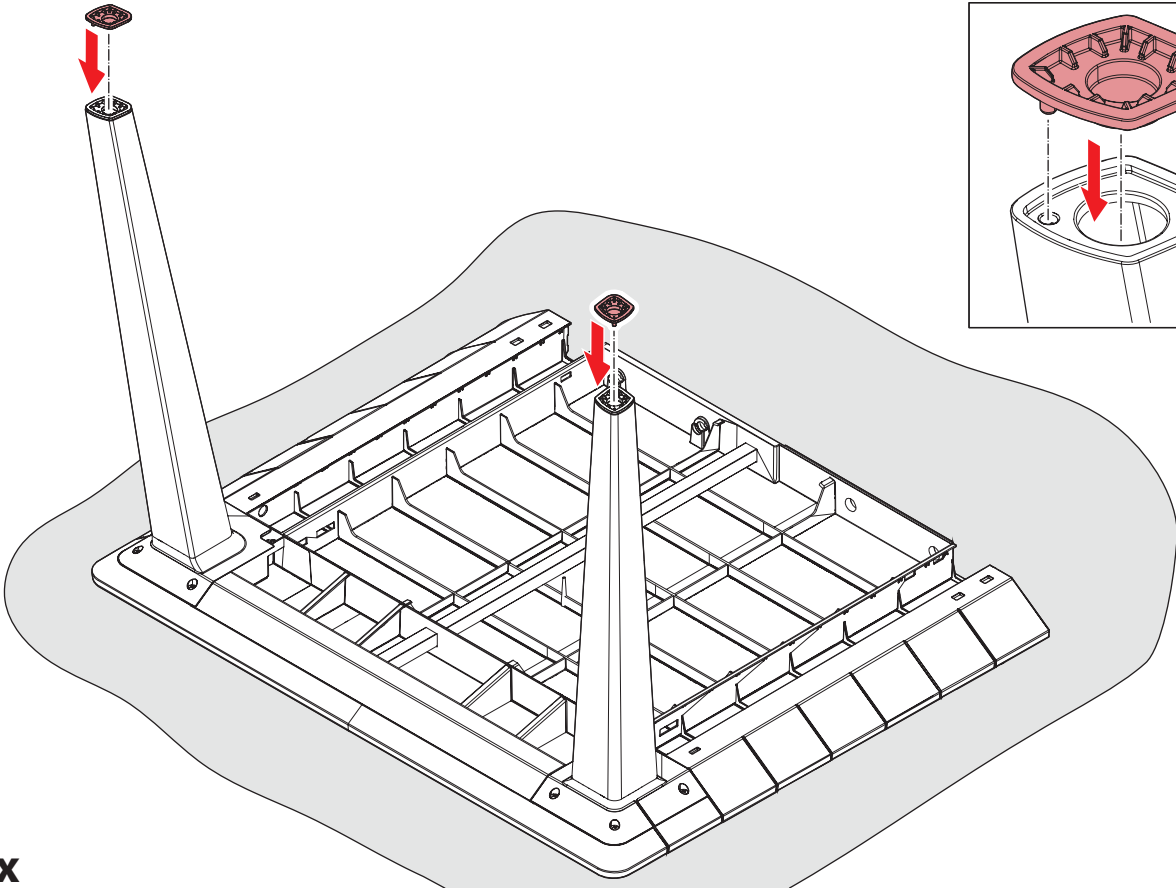
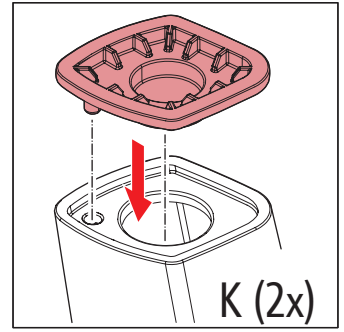

2x

3

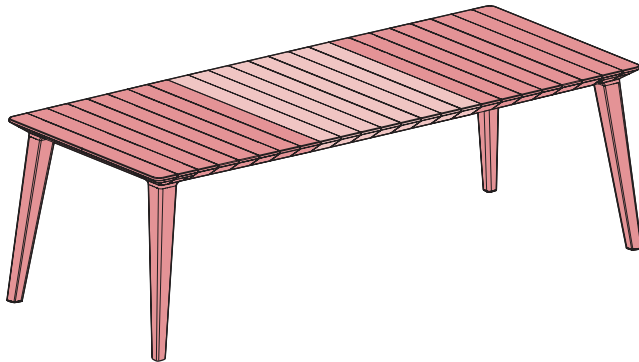

4

9

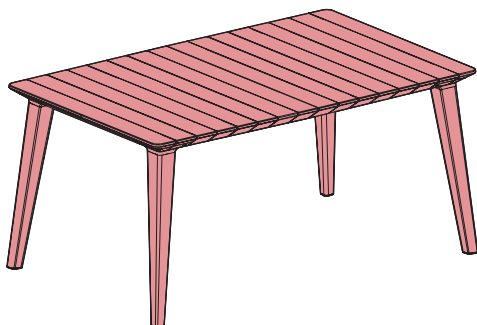

10

13

240

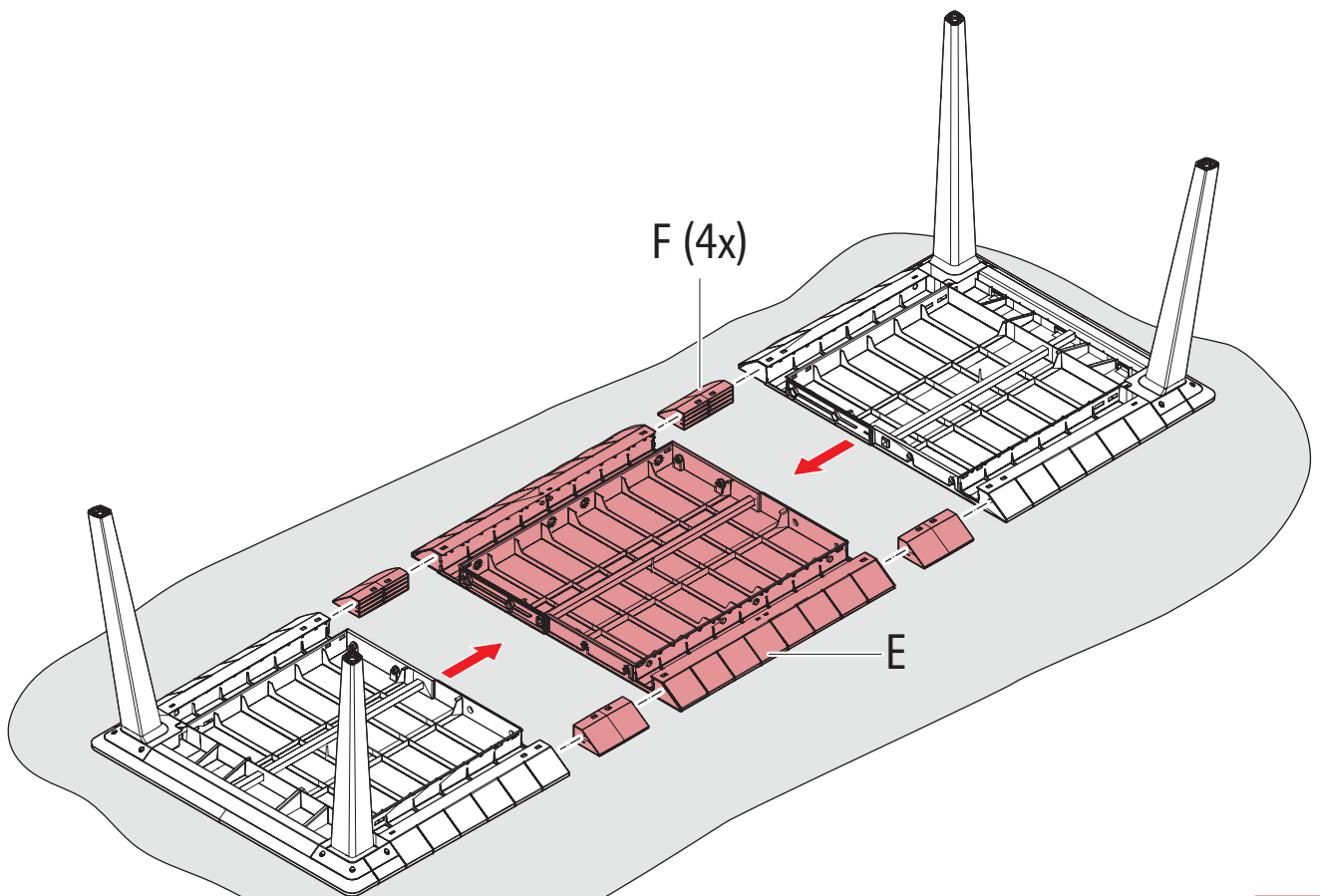
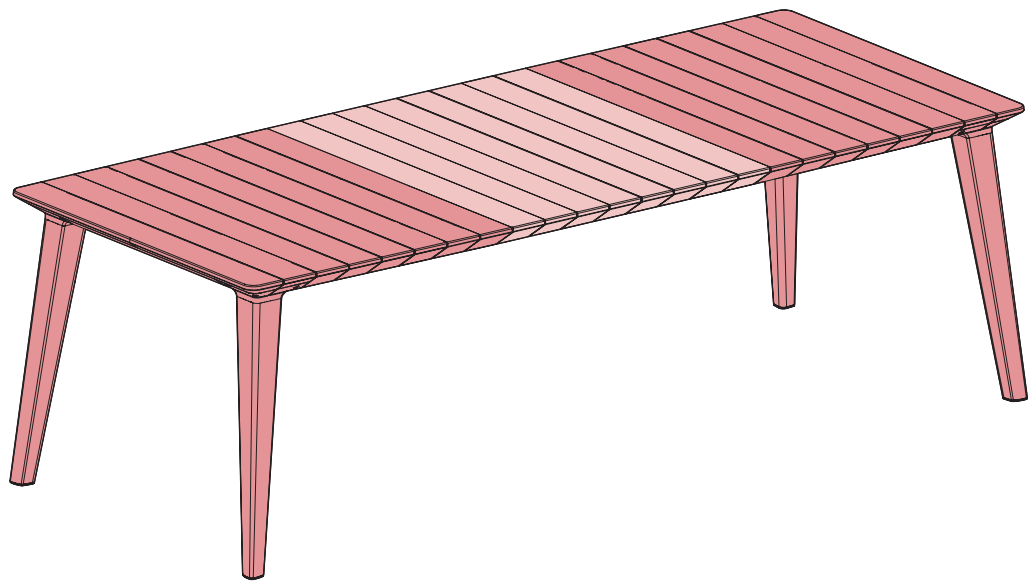

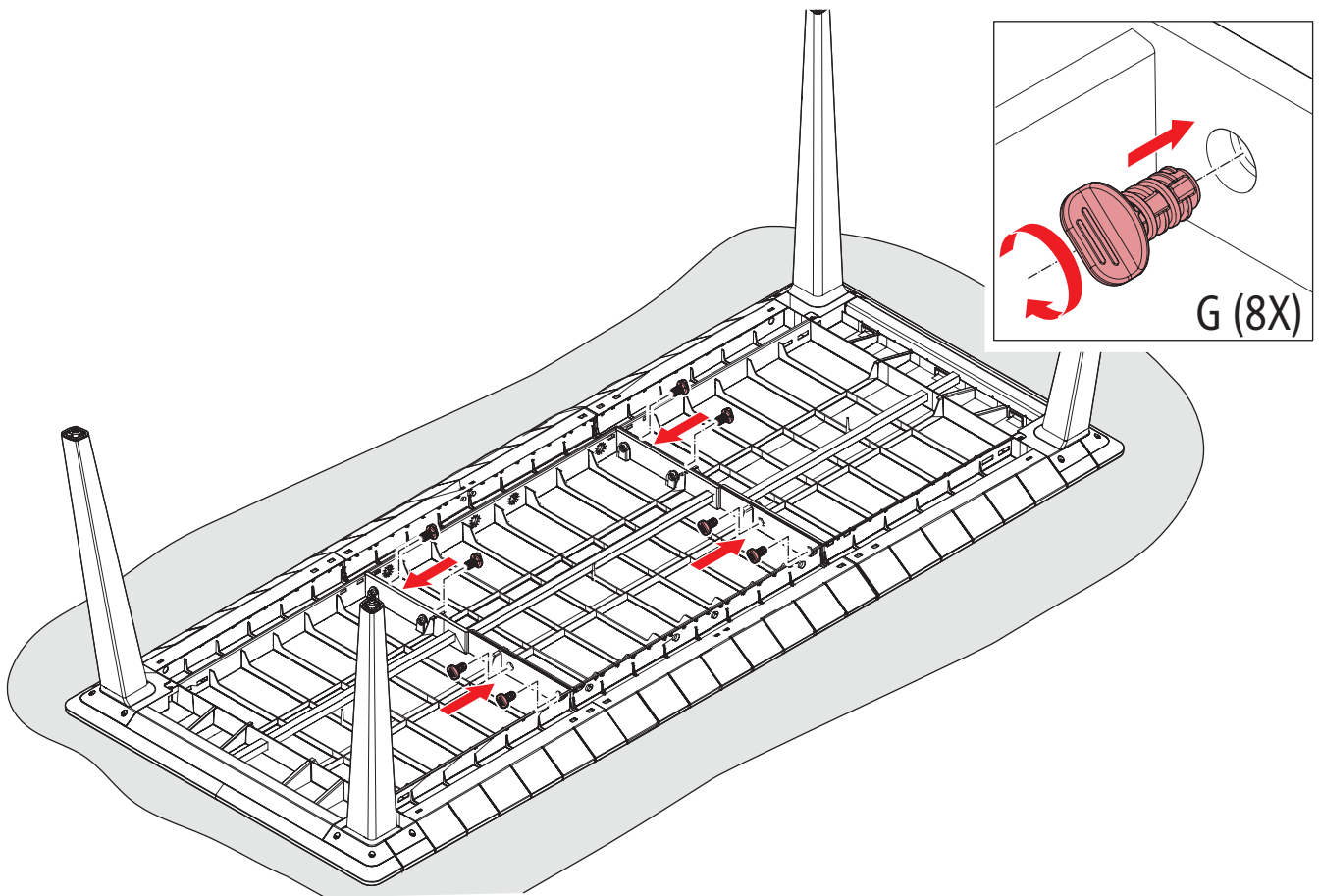

5

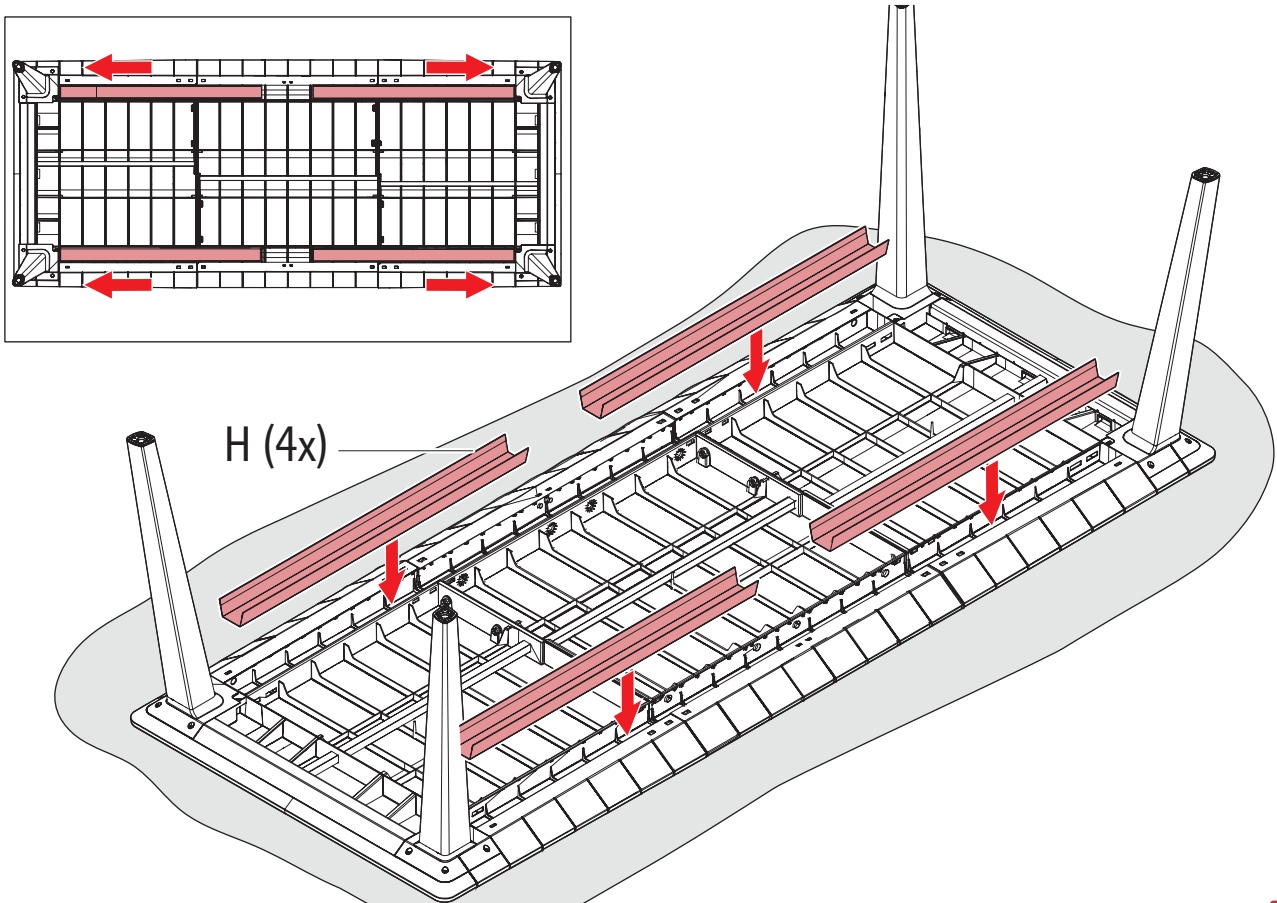

6

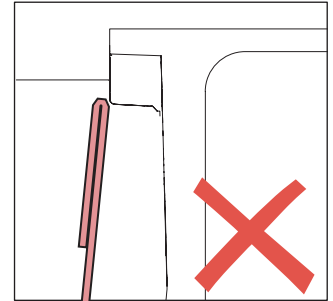
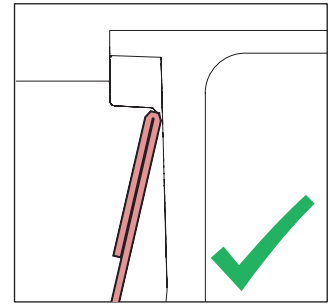
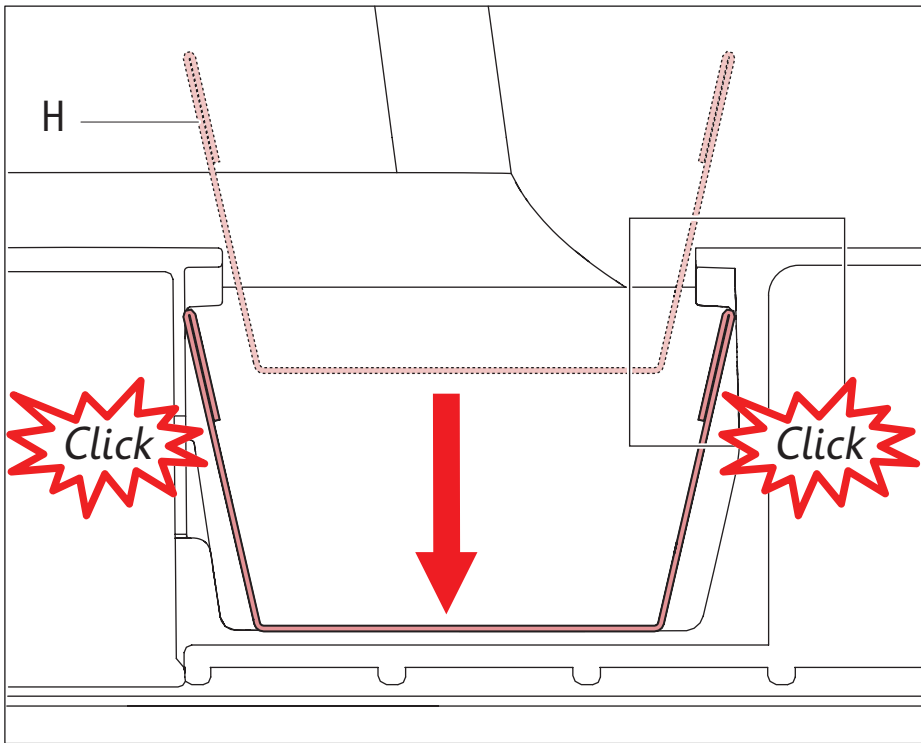

7

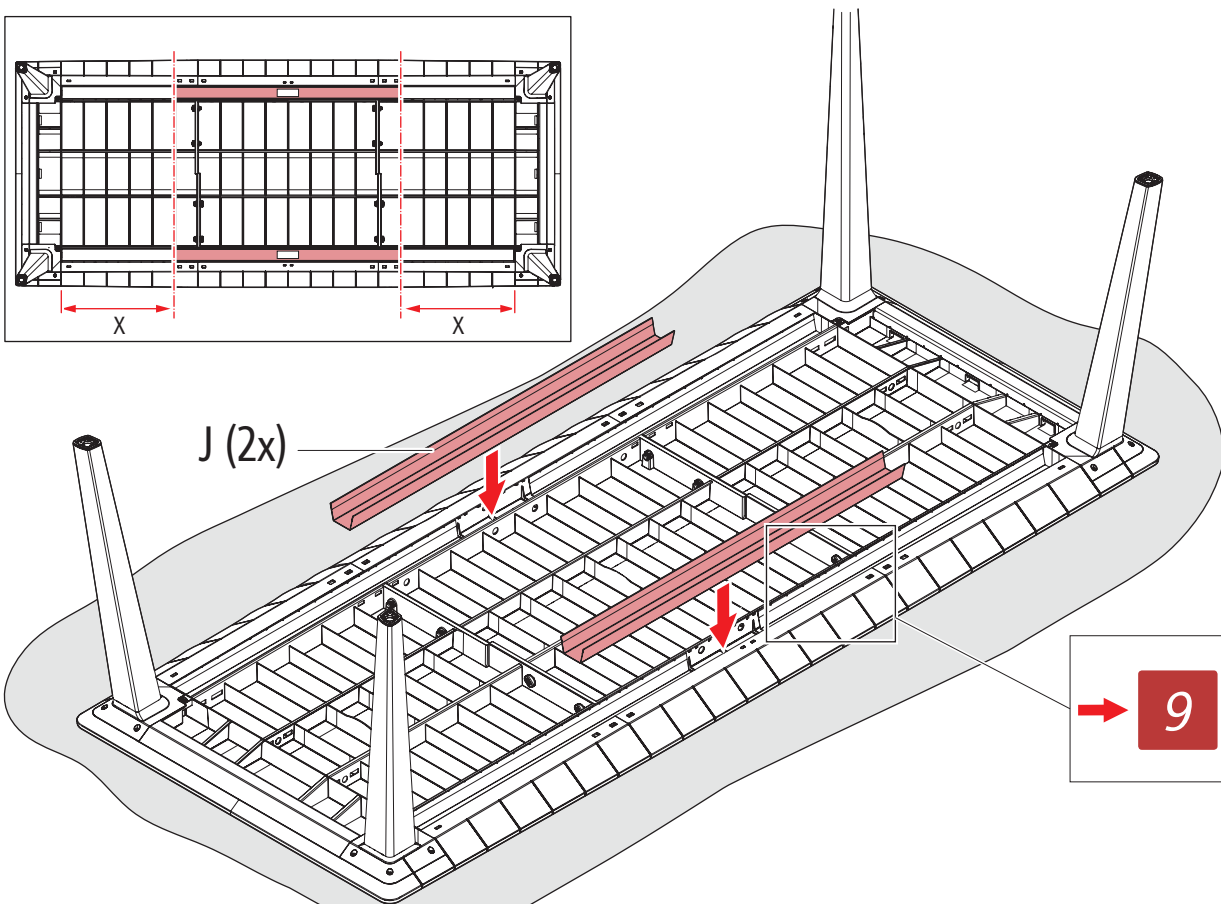
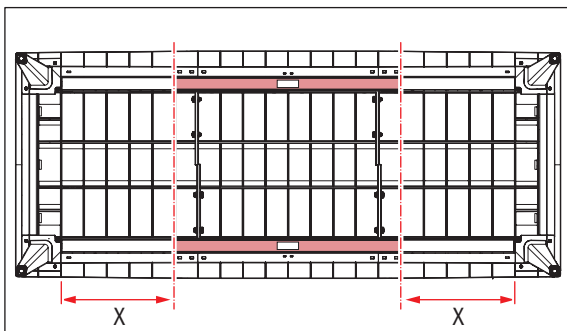

9

8

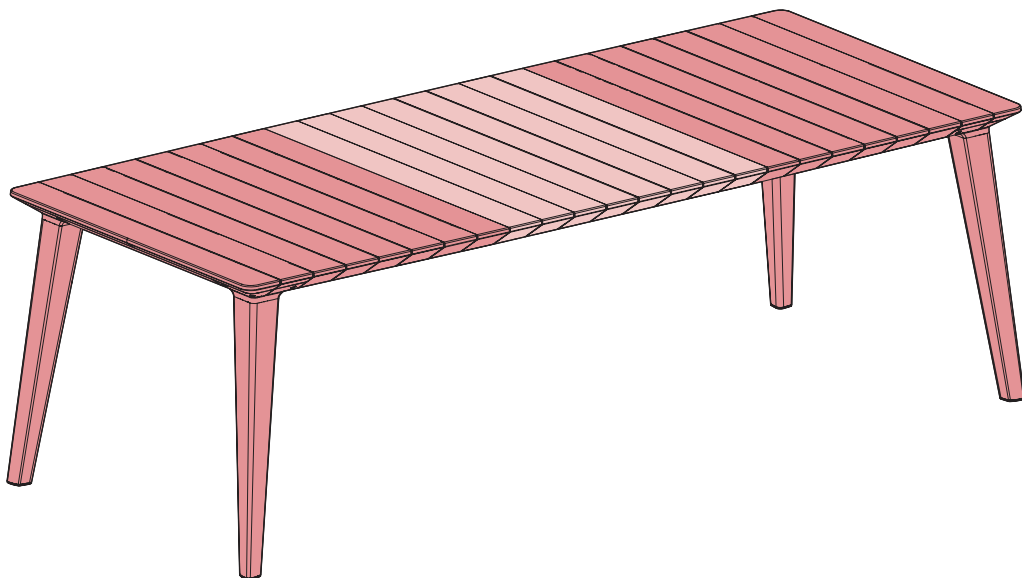
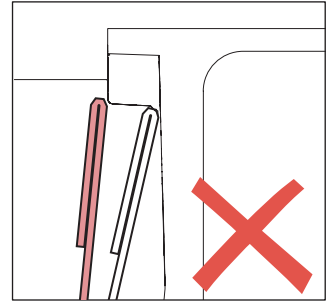
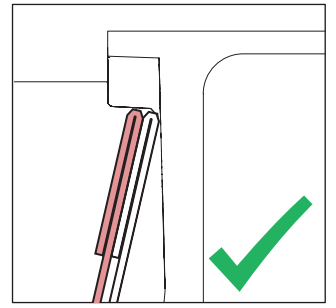
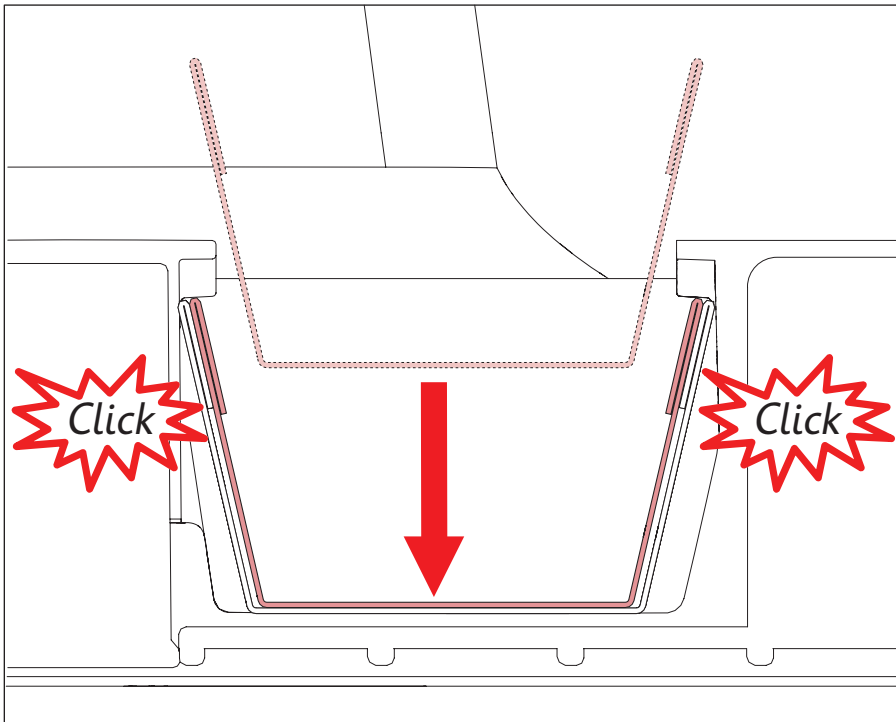

160

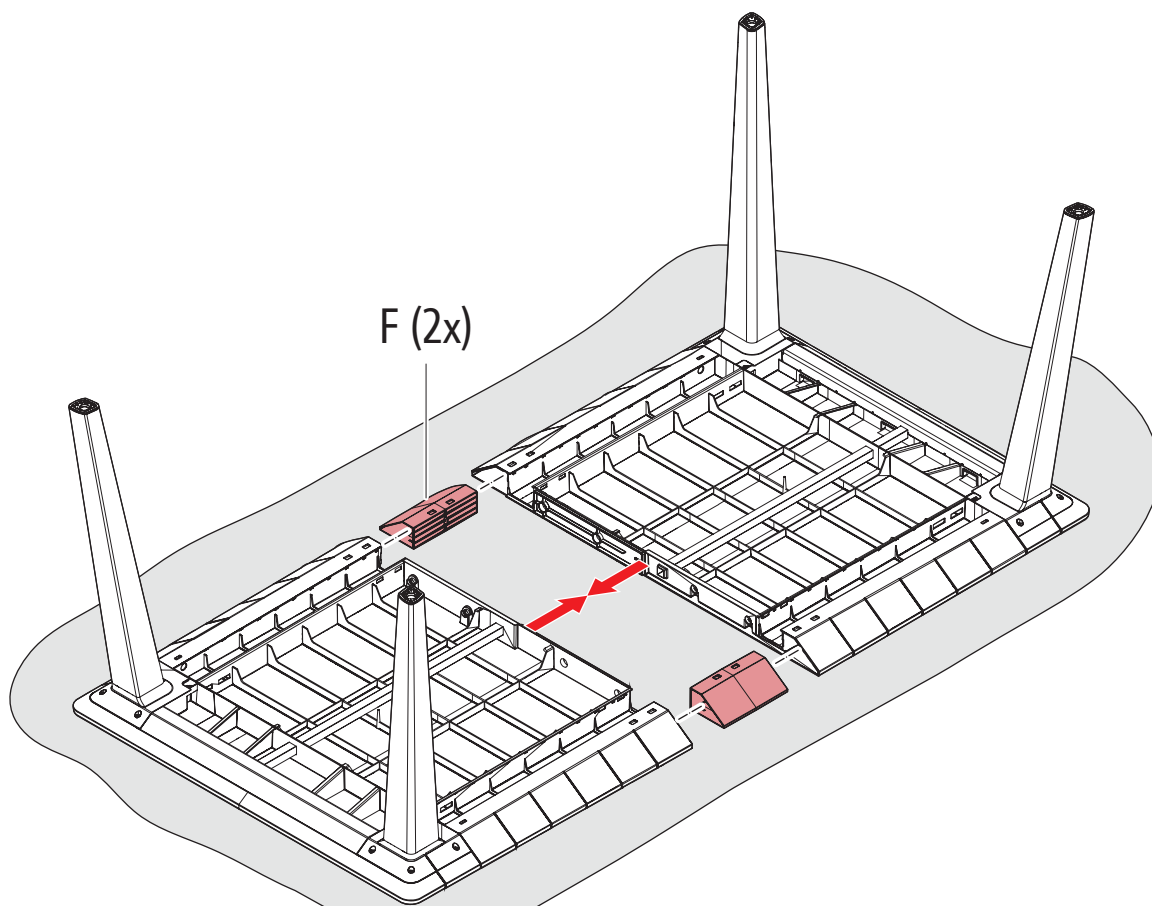
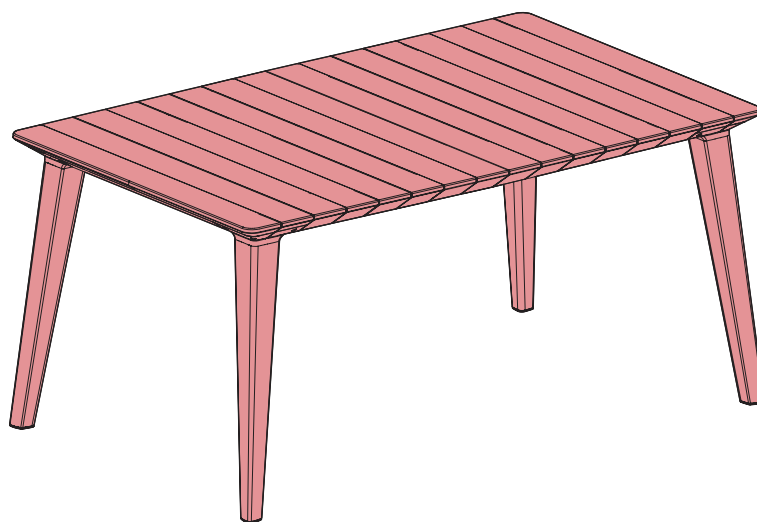

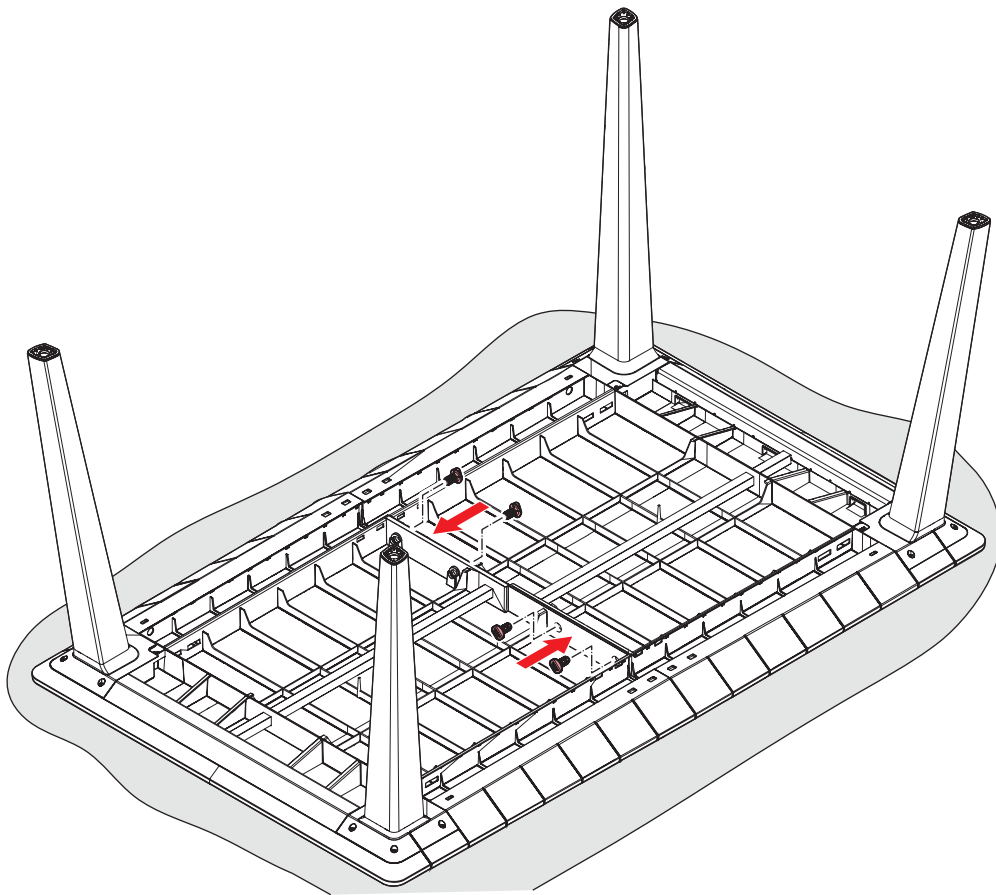

G (4X)

11

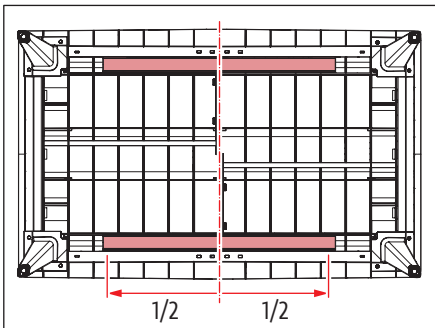

1/2 1/2

H (2x)

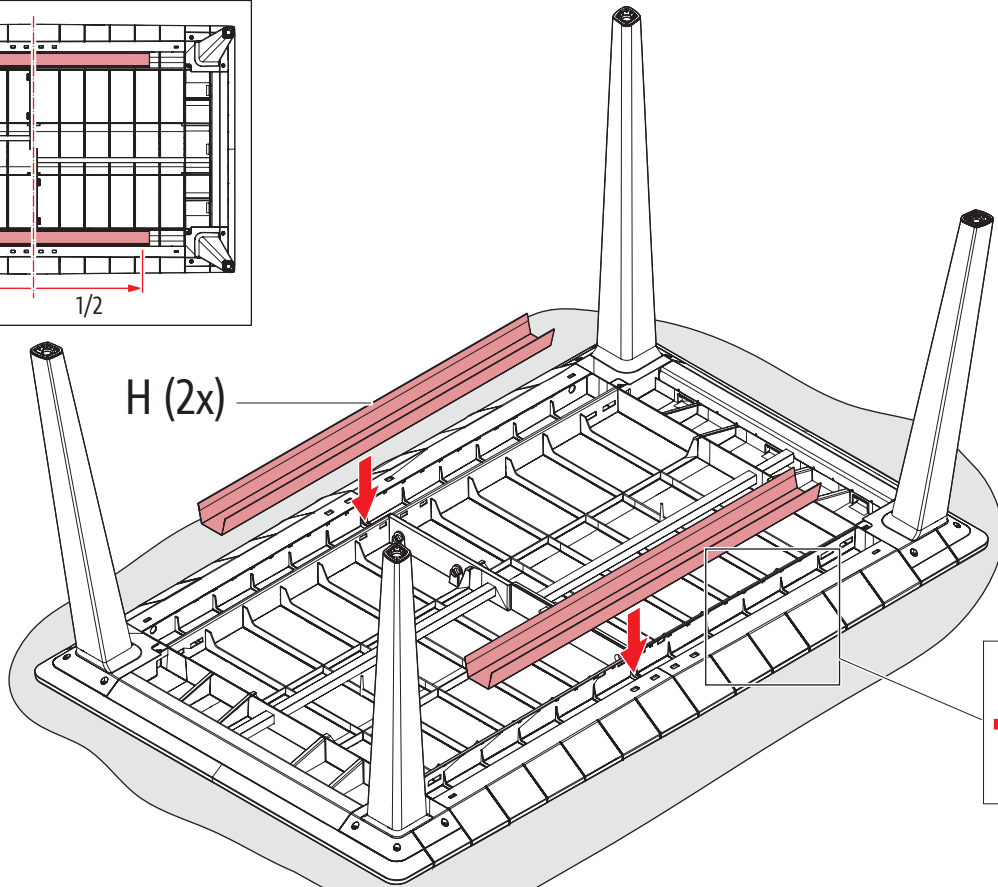

13

12

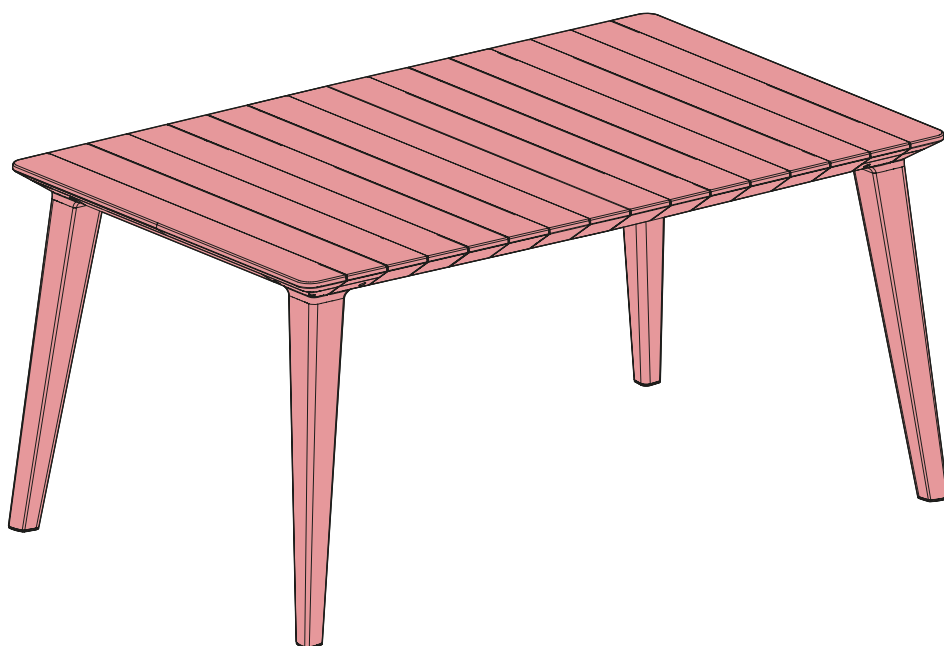
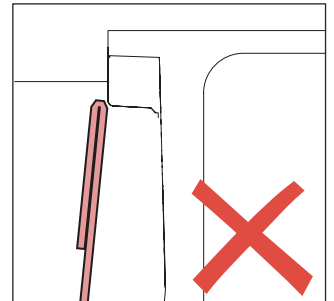
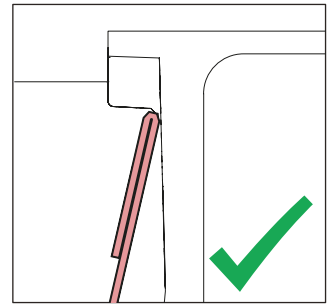
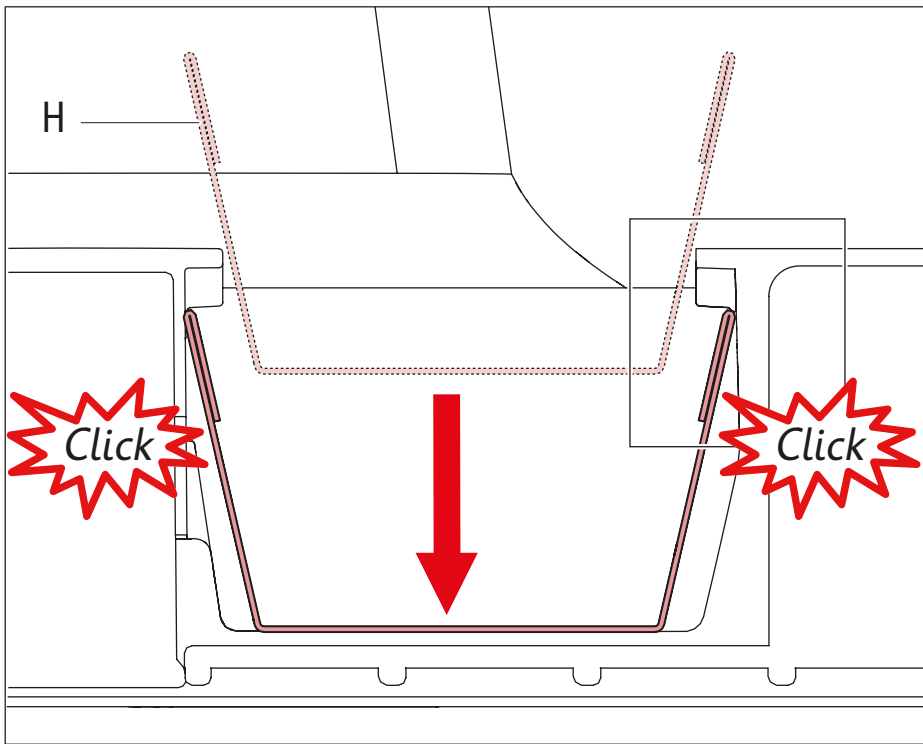

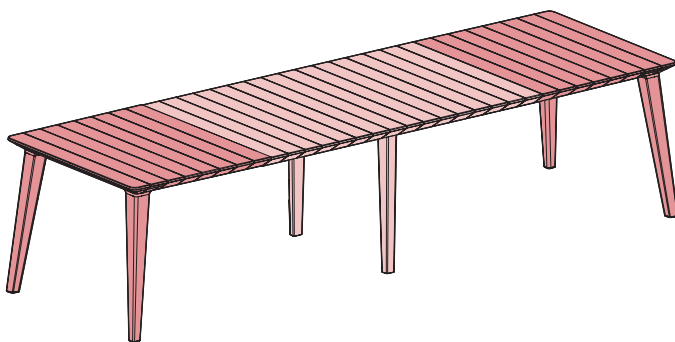
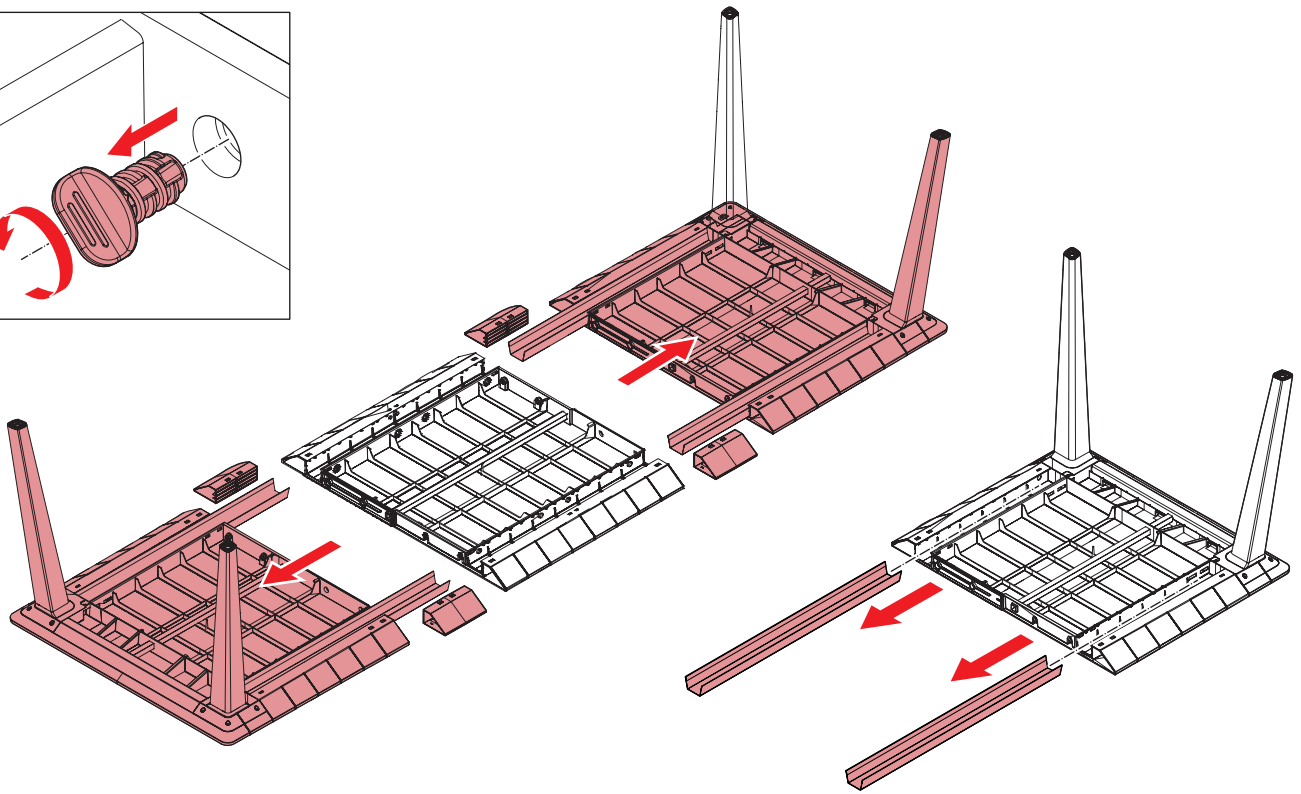
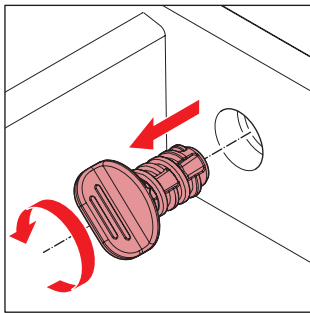
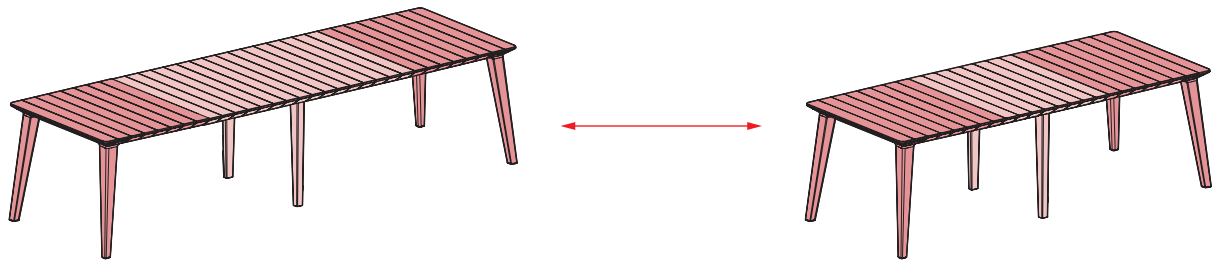

4 — 9

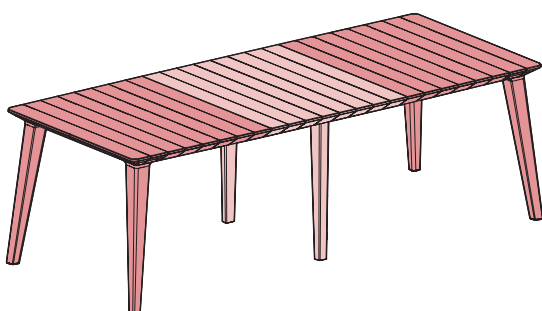

10 — 13