

# SALTA / SAPPORO

---

## 3 SEAT SOFA

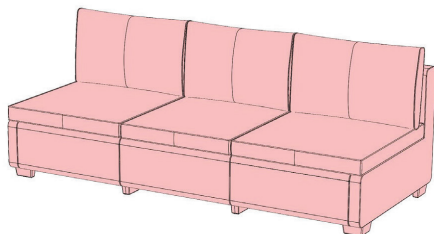
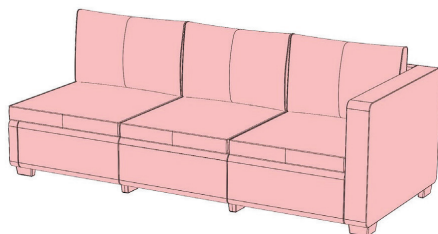
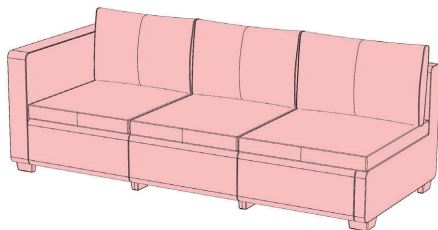
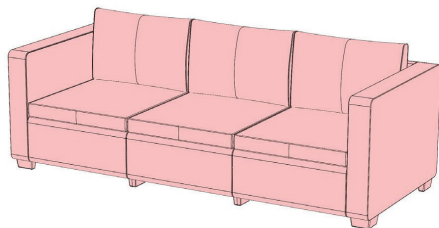

SALTA/SAPPORO 3- SOFA V1.3 / 5001519 / 442262.442262







5011146





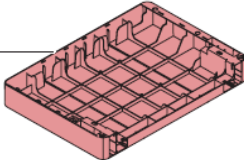
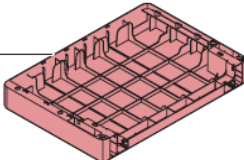
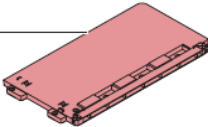
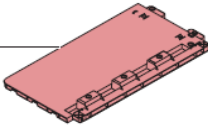
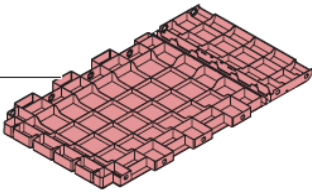
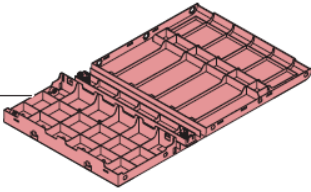
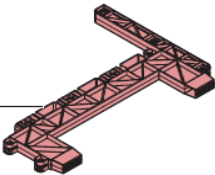

Ericssonstraat 17, 5121 MK Rijen, The Netherlands  
Made in Hungary KETER Hungary Kft., Zsong-volgy 2, 4211 Ebes, Hungary  
[gpsr.ketereu@keter.com](mailto:gpsr.ketereu@keter.com)

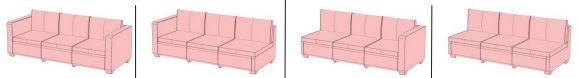

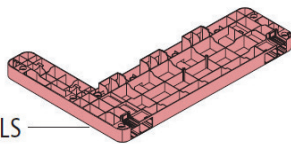
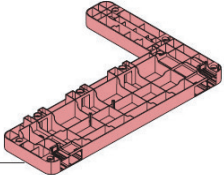
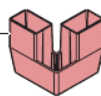

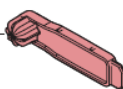
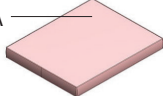
				
RS 	1x	1x	-	-
LS 	1x	-	1x	-
LSC 	1x	-	1x	-
RSC 	1x	-	1x	-
S 	3x	3x	3x	3x
B 	3x	3x	3x	3x
ML 	2x	2x	2x	2x

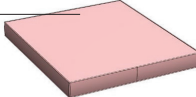

 <p>LS</p>	-	1x	-	1x
 <p>RS</p>	-	-	1x	1x
 <p>L</p>	4x	4x	4x	4x
 <p>M</p>	46x +9 extra	46x +9 extra	46x +9 extra	46x +9 extra
 <p>Z</p>	1x +4 extra	1x +4 extra	1x +4 extra	1x +4 extra
 <p>SCA</p> <p>Seat cushion A 72x59 cm 28x23 in</p>	3x	2x	2x	1x
 <p>BCA</p> <p>Back cushion A 50x65 cm 19,5x25,5 in</p>	3x	2x	2x	1x
 <p>SCB</p> <p>Seat cushion B 72x65 cm 28x25,5 in</p>	-	1x	1x	2x
 <p>BCB</p> <p>Back cushion B 50x71 cm 19,5x28 in</p>	-	1x	1x	2x

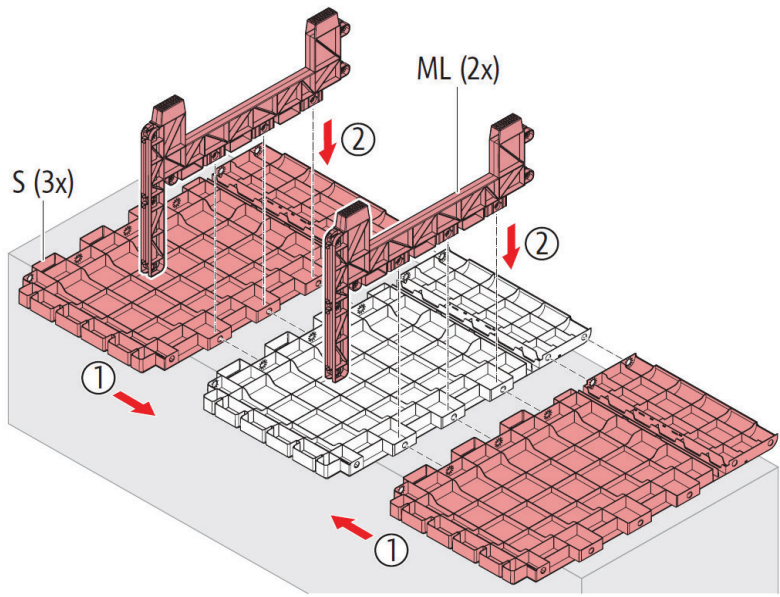

1

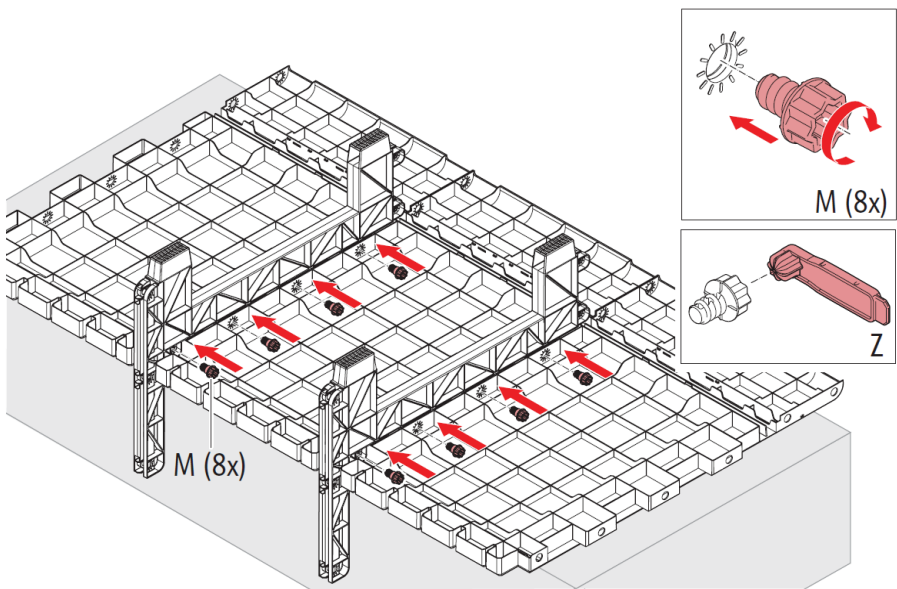

2

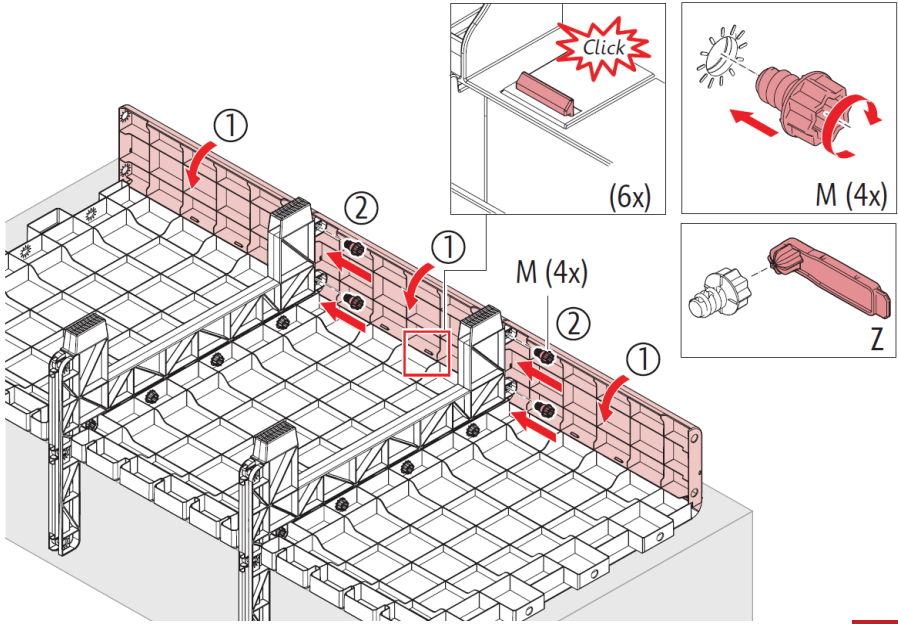

**3**

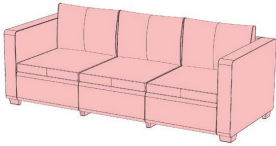

**4** — **14**

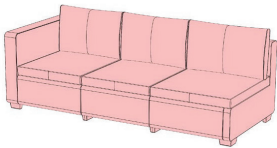

**15** — **23**

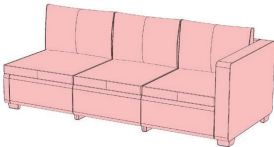

**24** — **32**

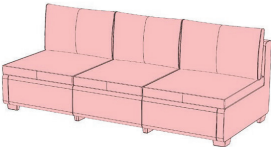

**33** — **39**

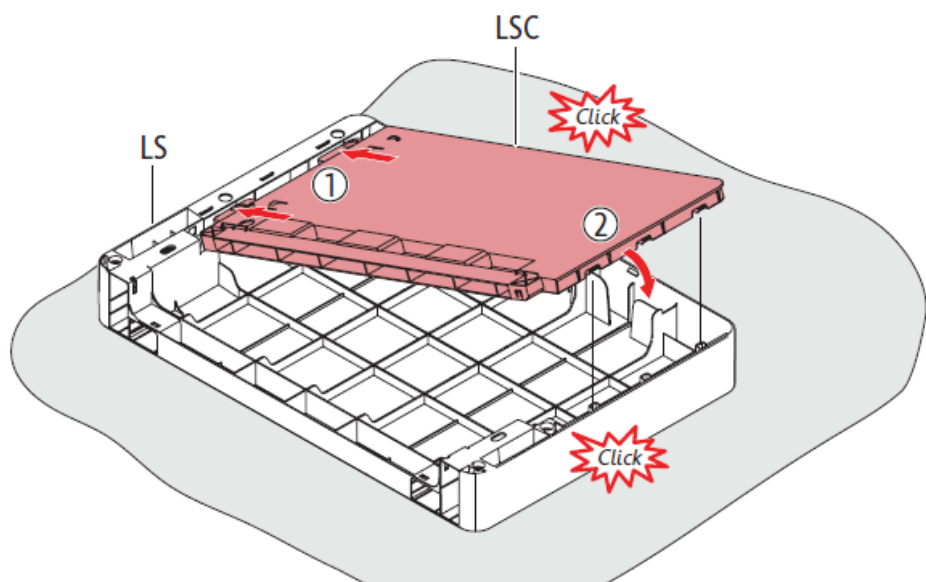

4

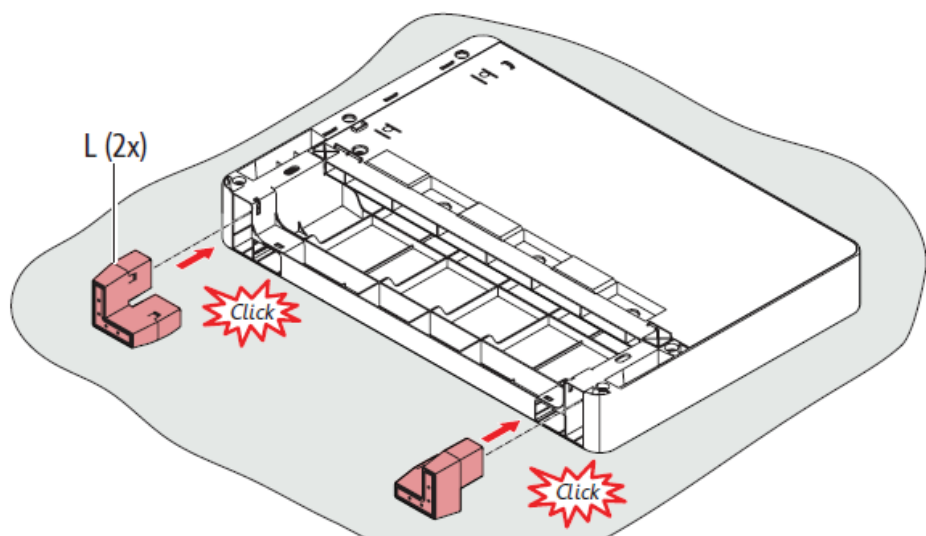

5



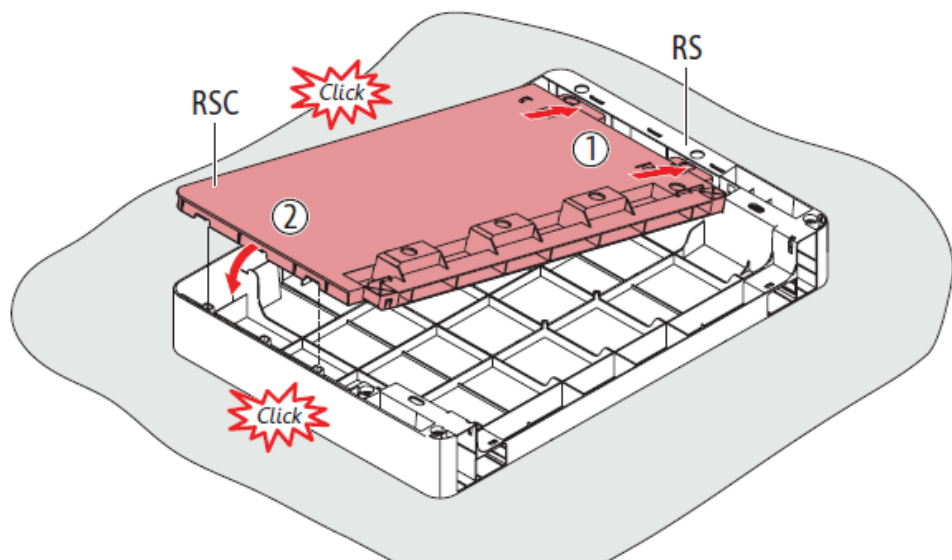

6

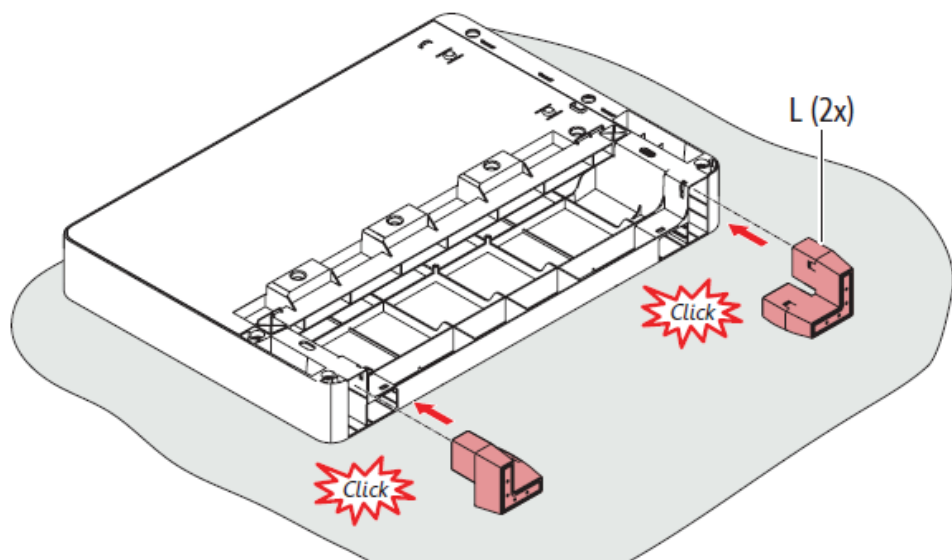

7

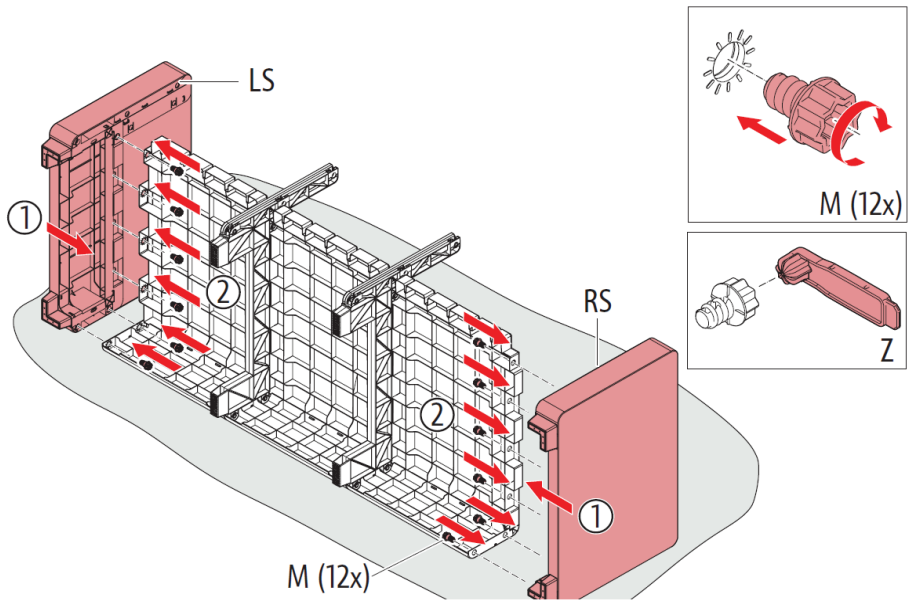

8

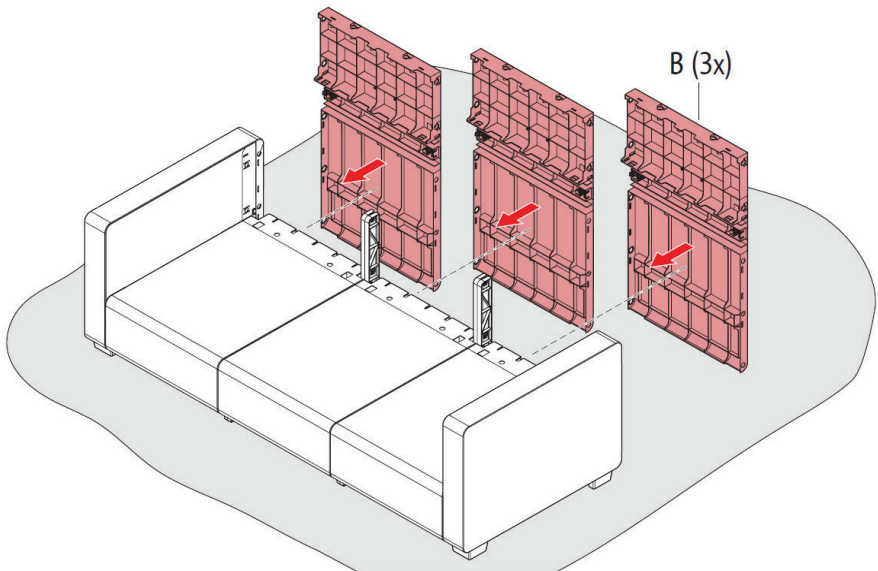

9

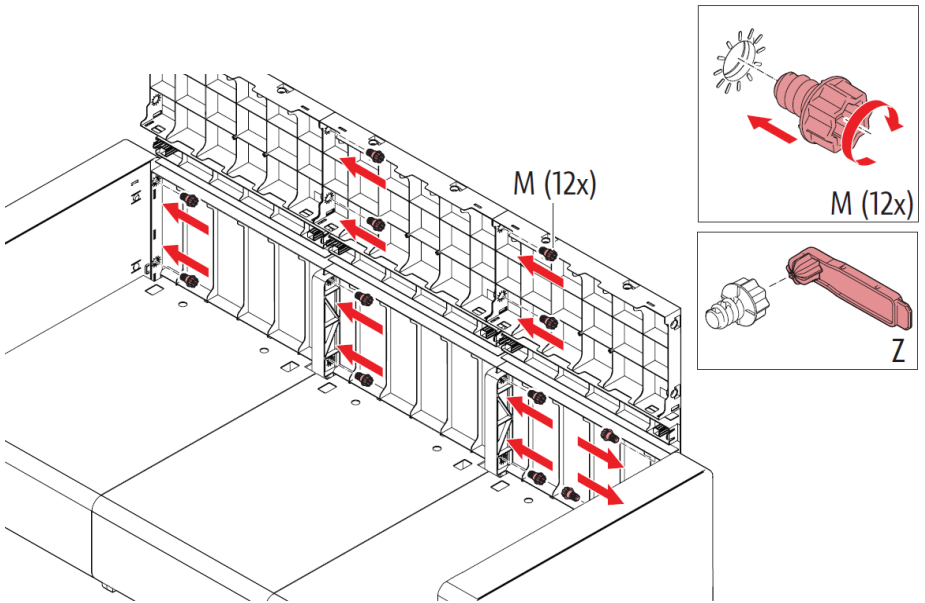

10

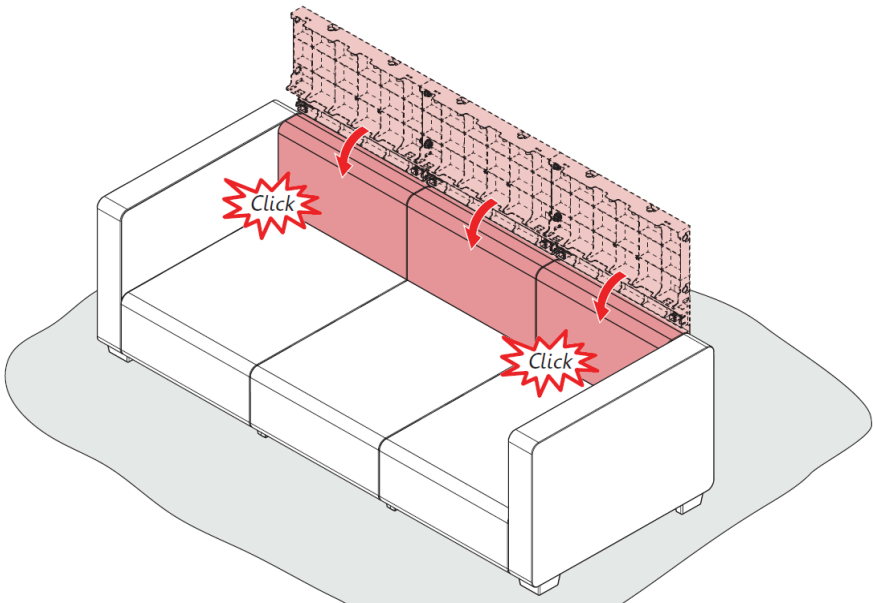

11



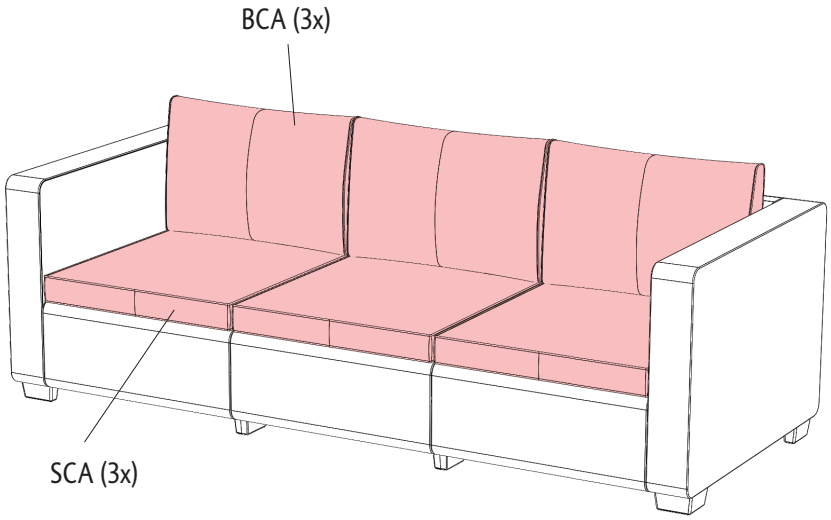

---

14

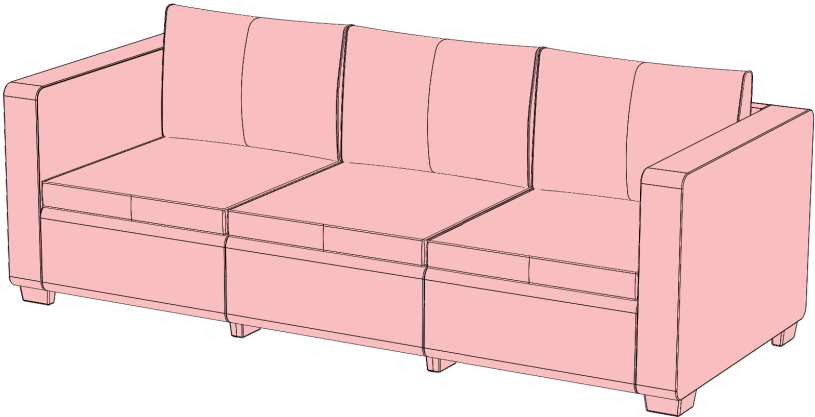

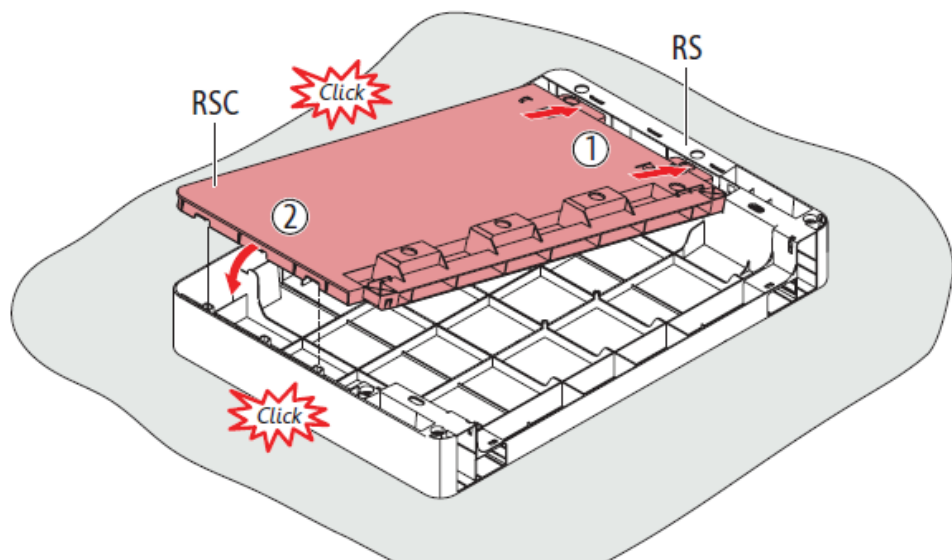

15

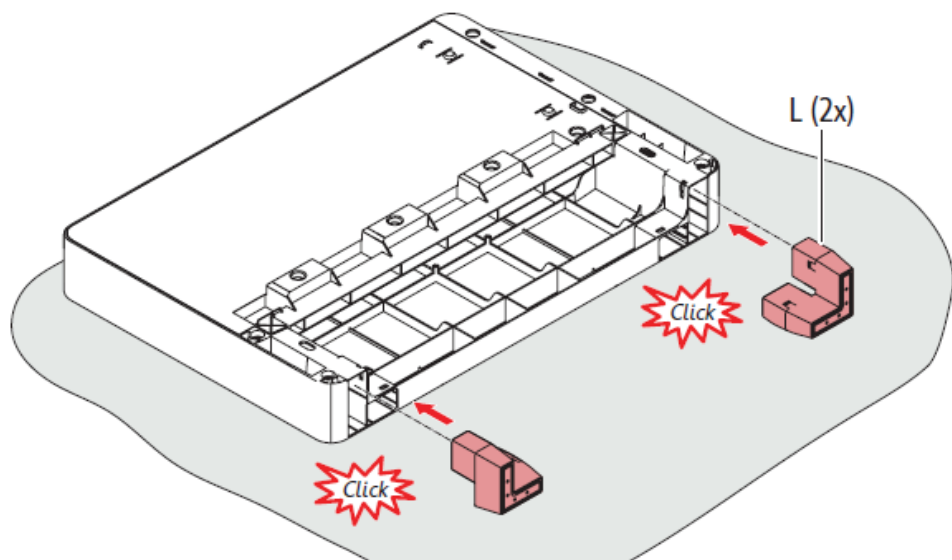

16

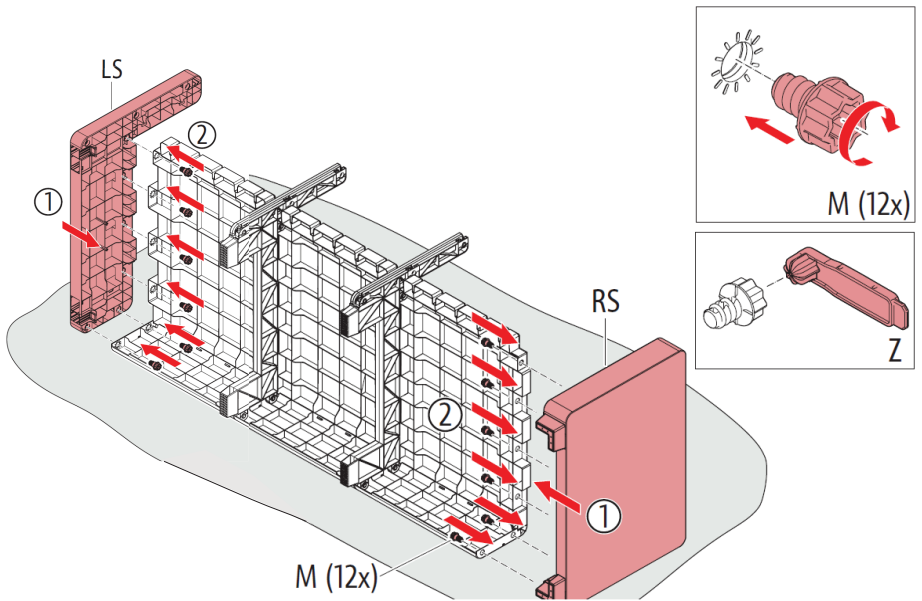

17

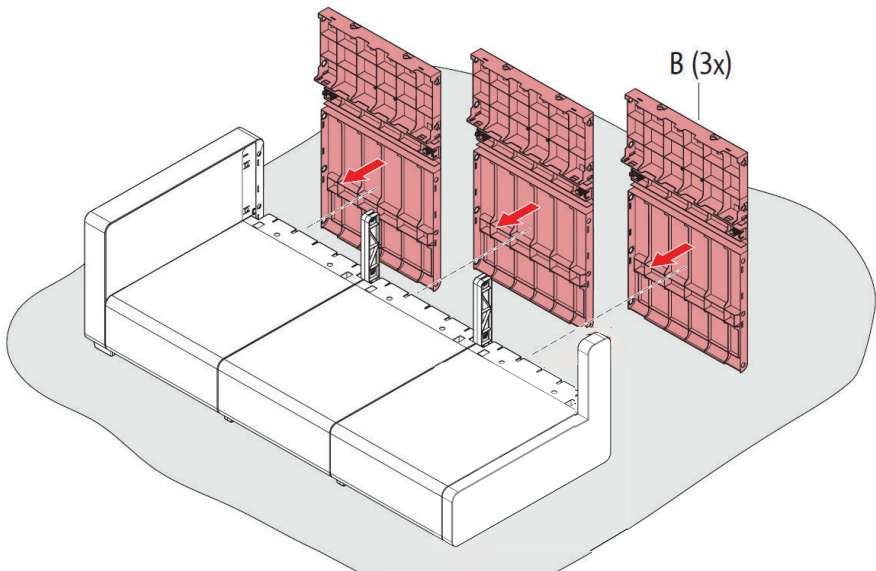

18

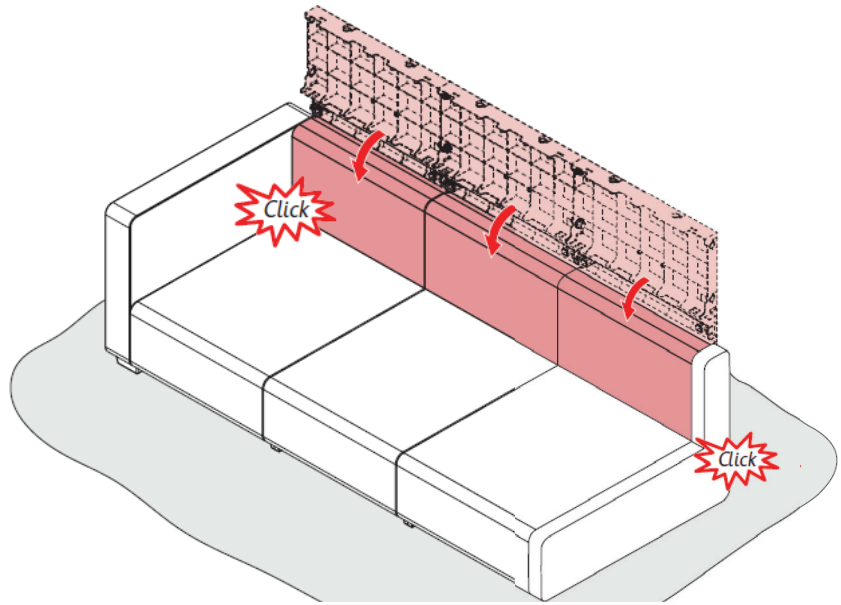
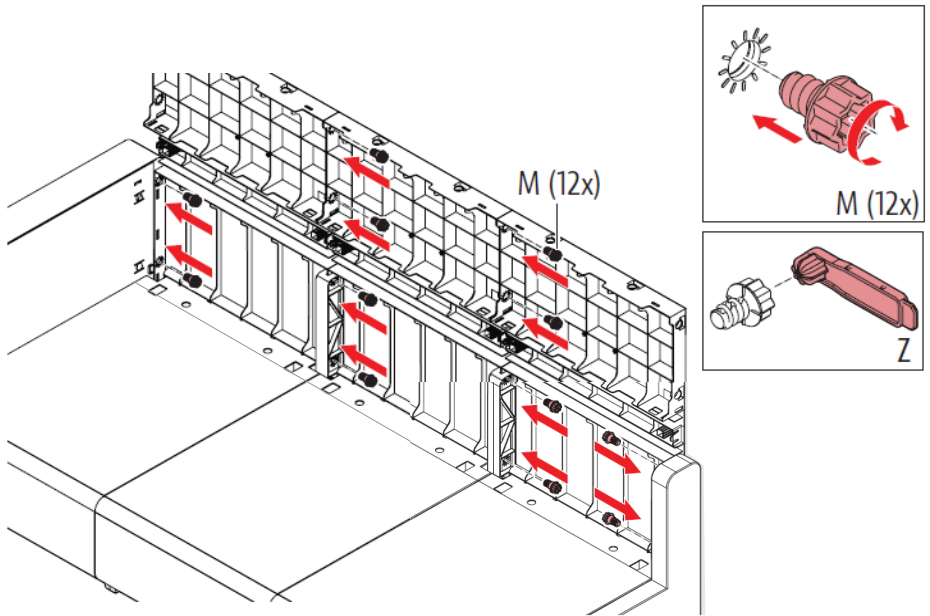



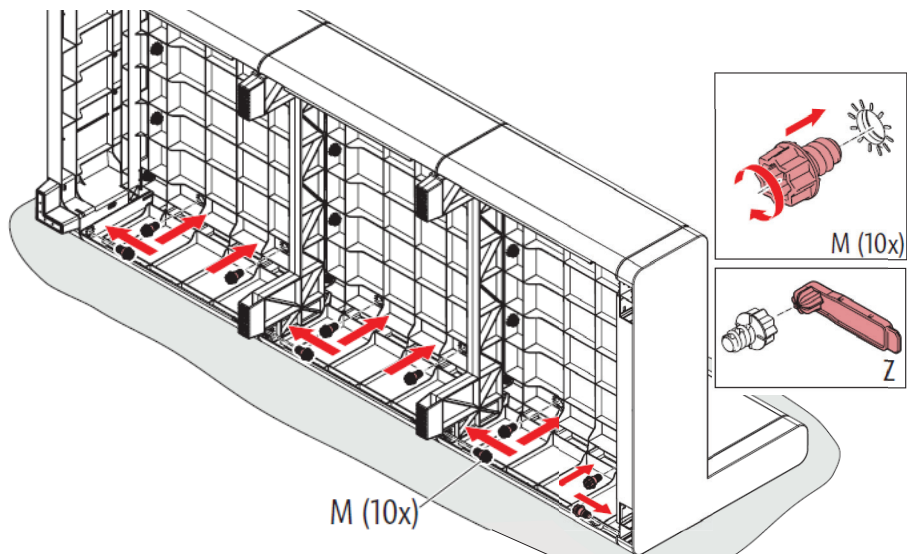

21

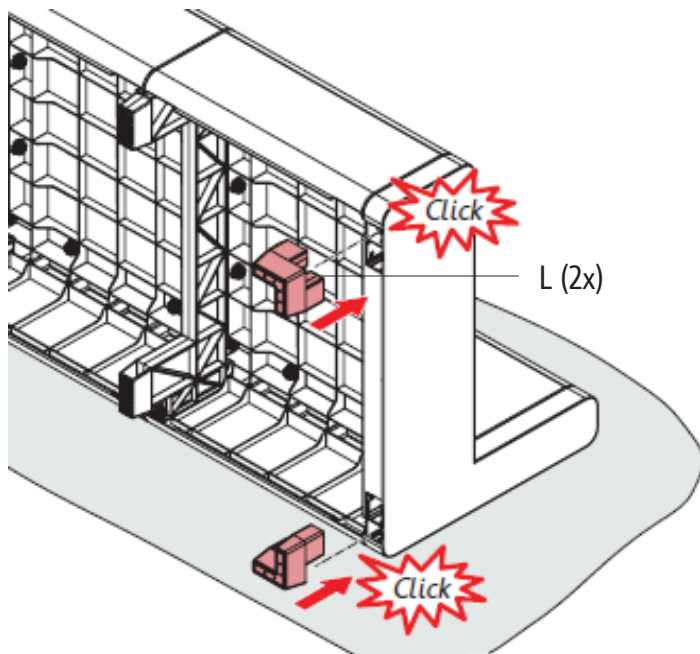

22

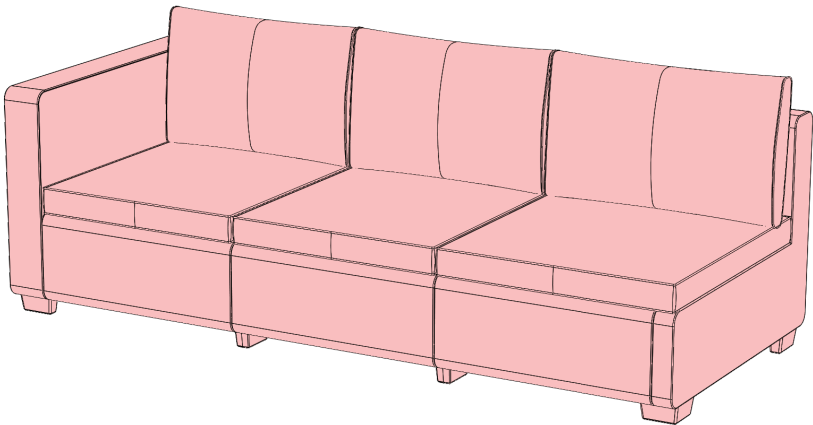
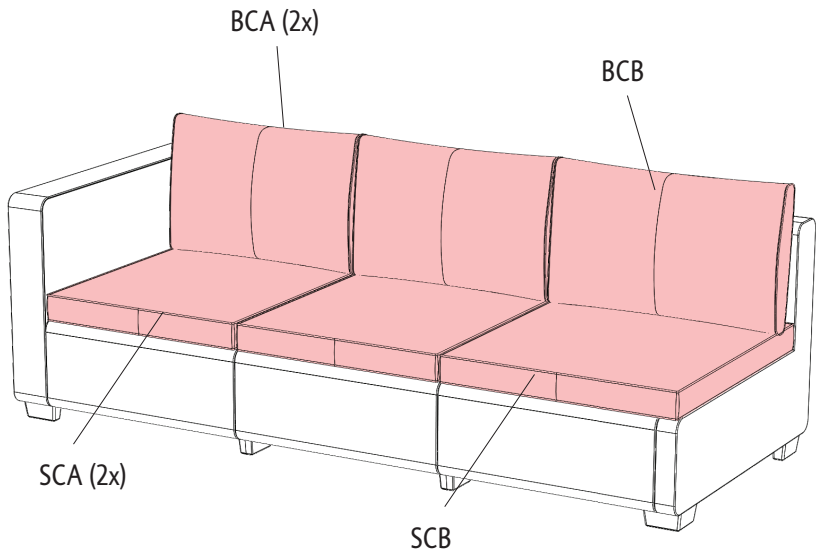

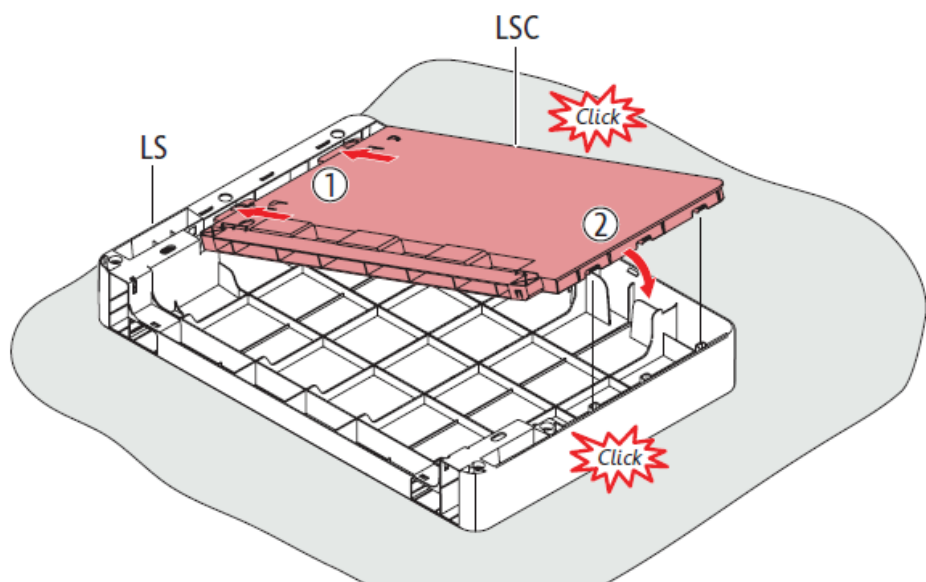

24

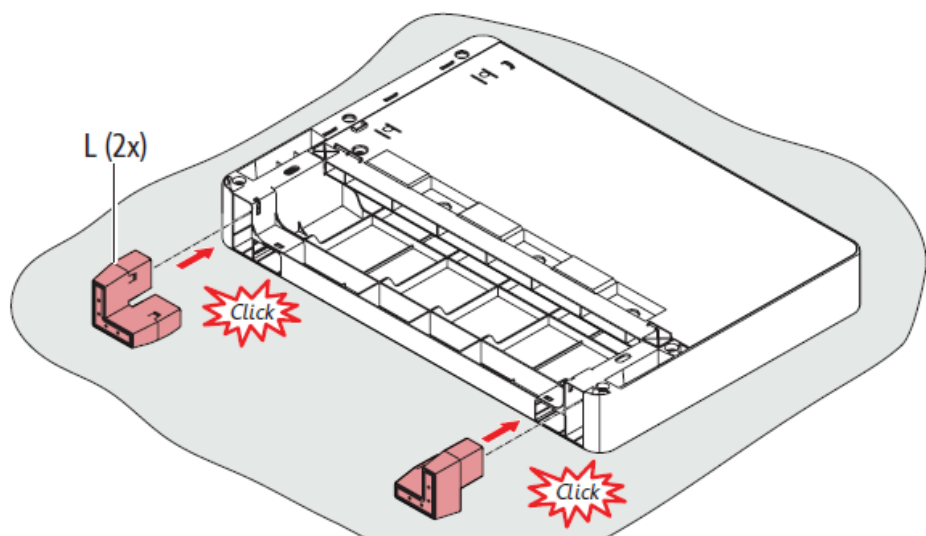

25

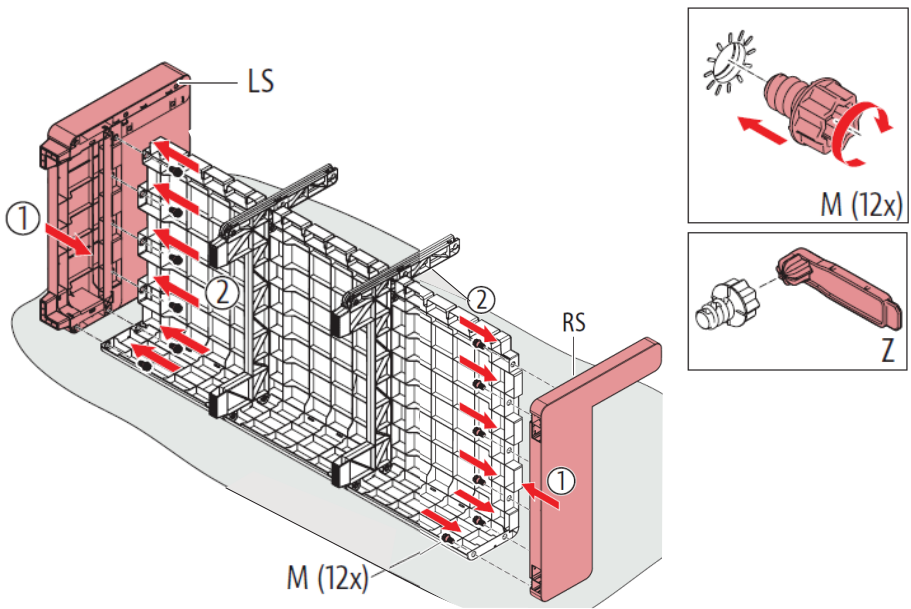

26

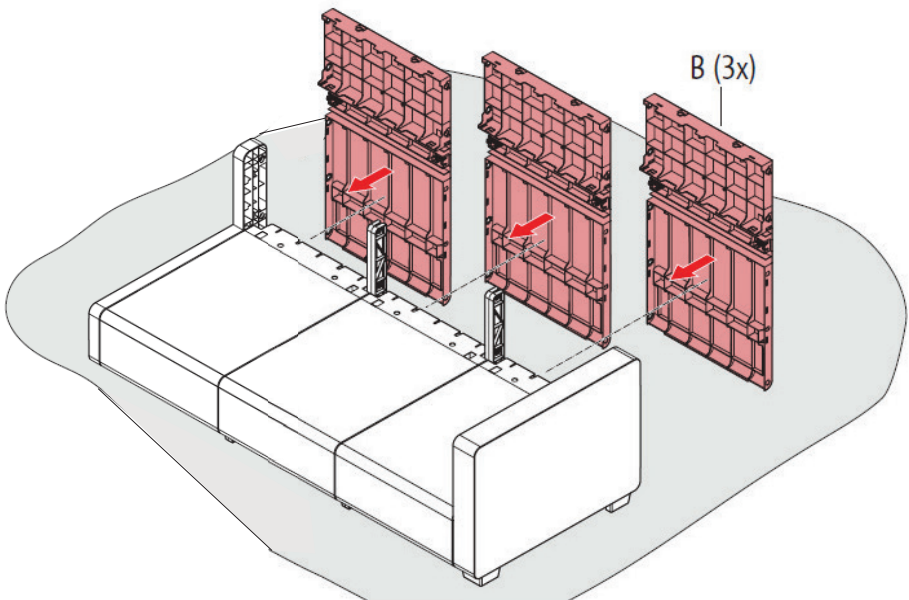

27

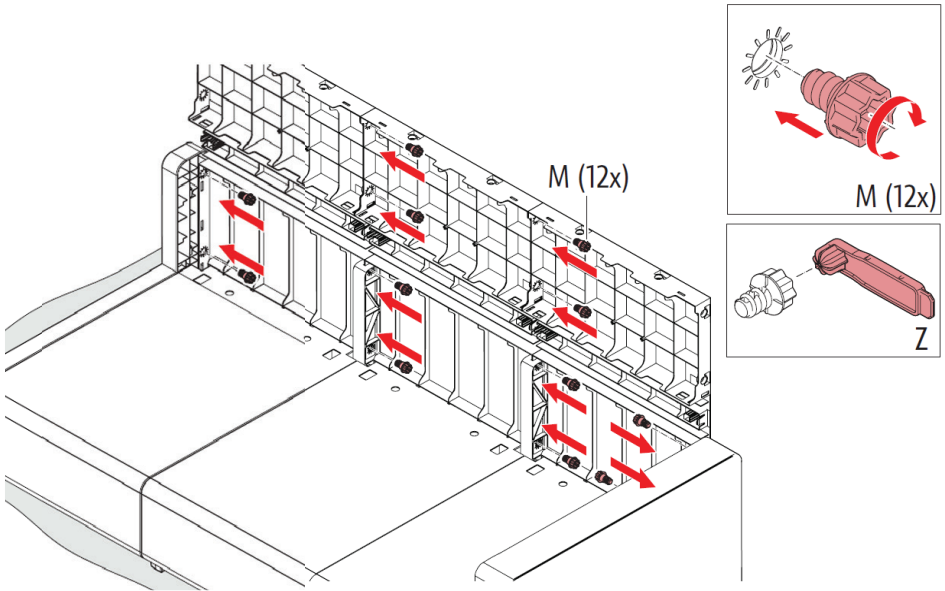

28

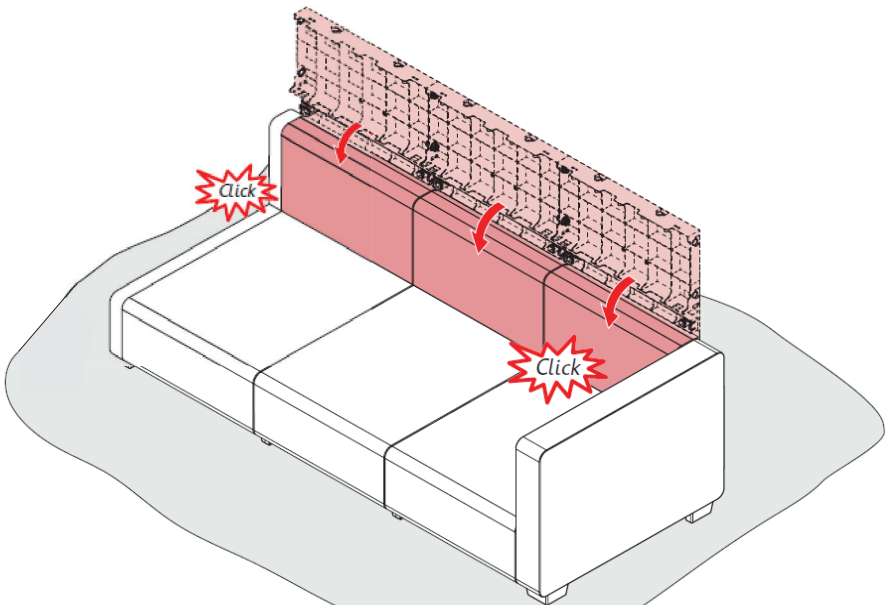

29

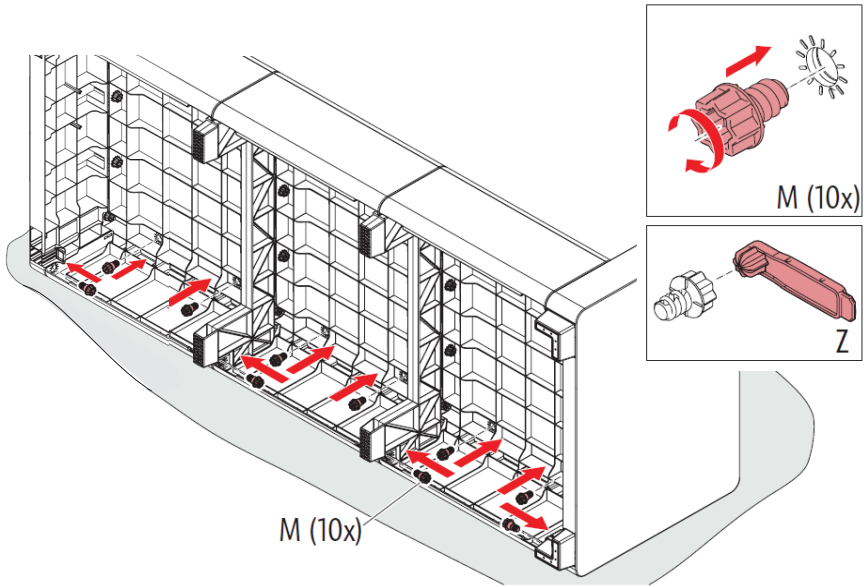

30

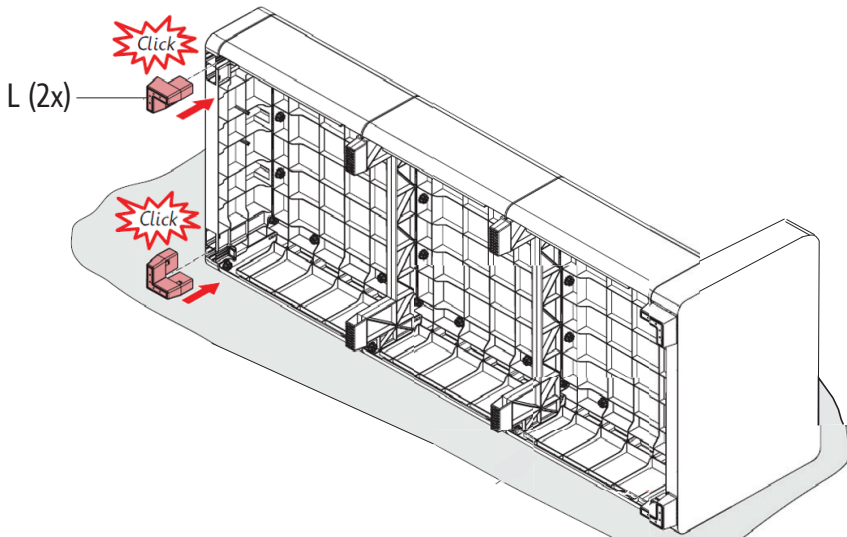

31

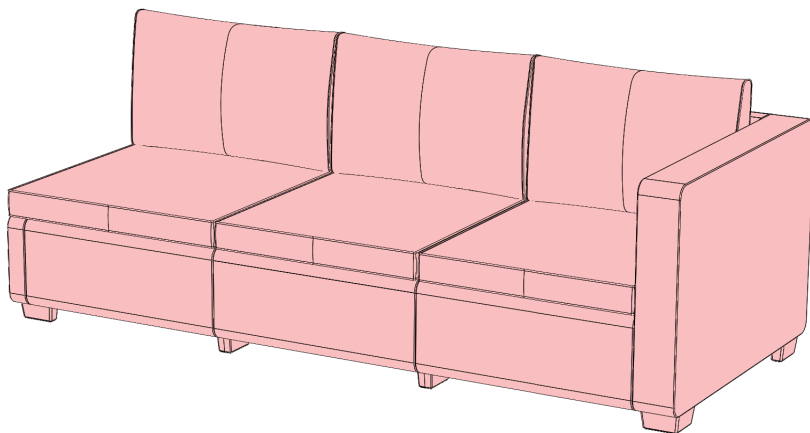
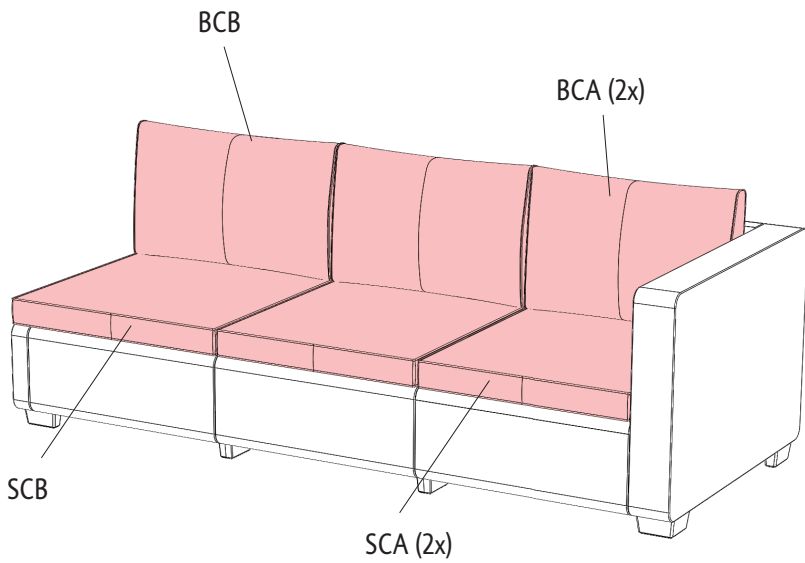

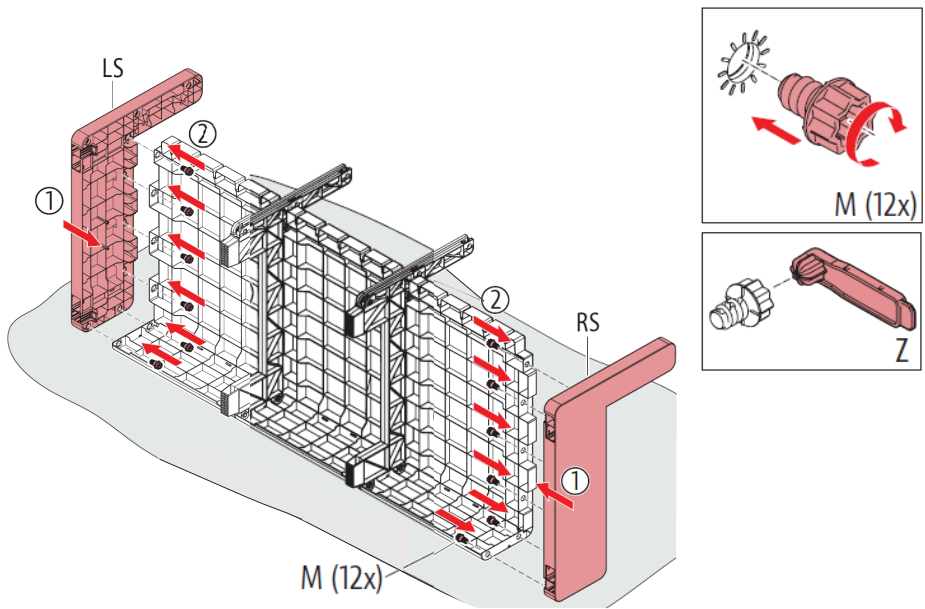

33

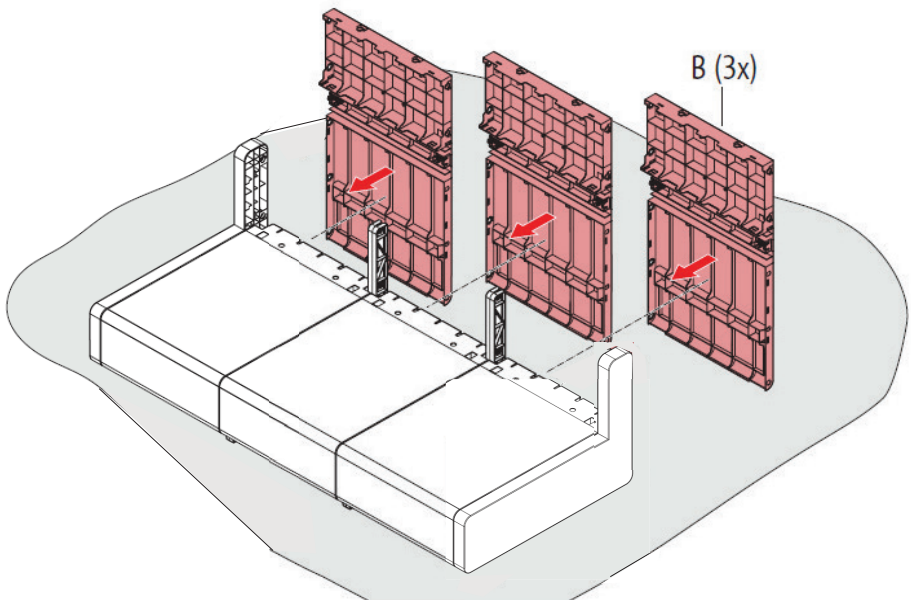

34



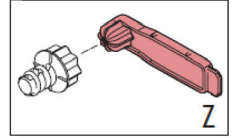
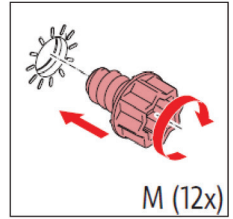
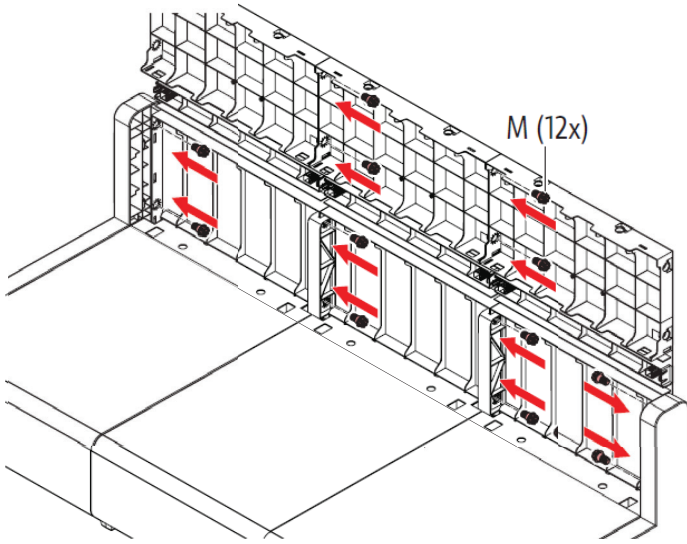

35

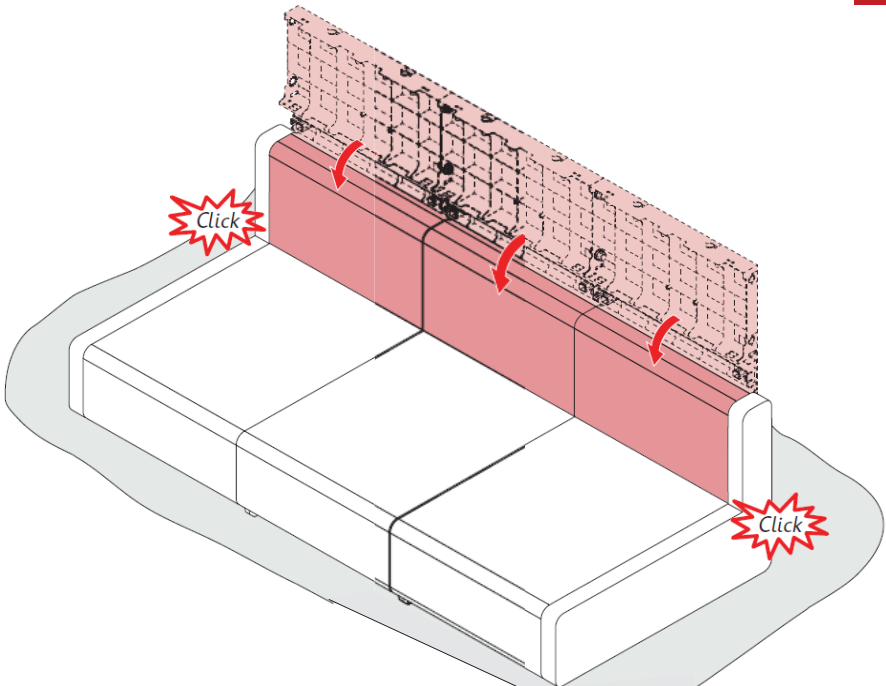

36

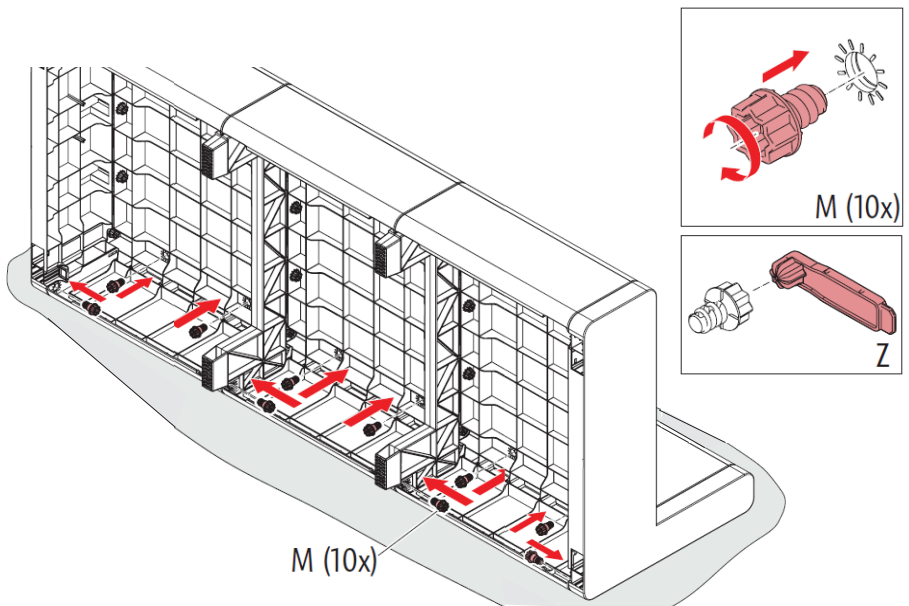

37

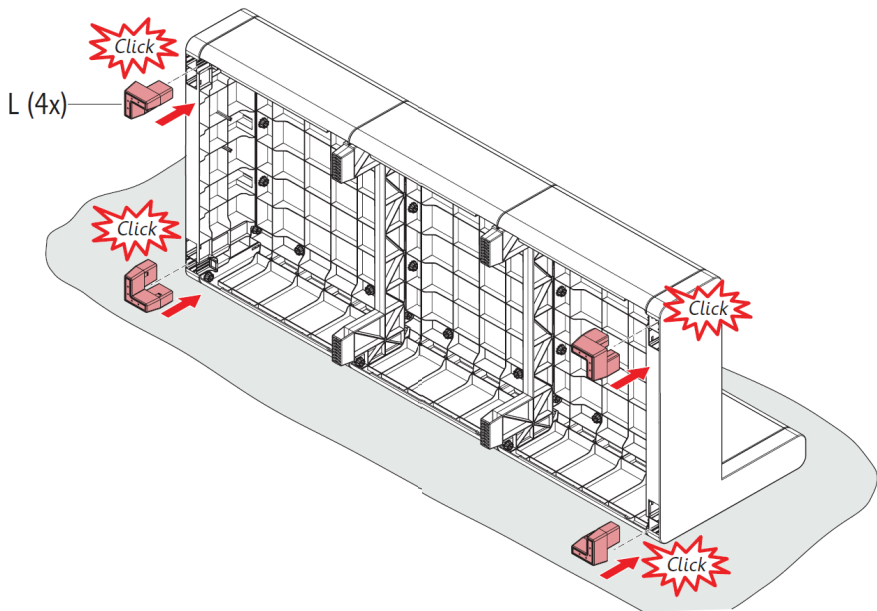

38

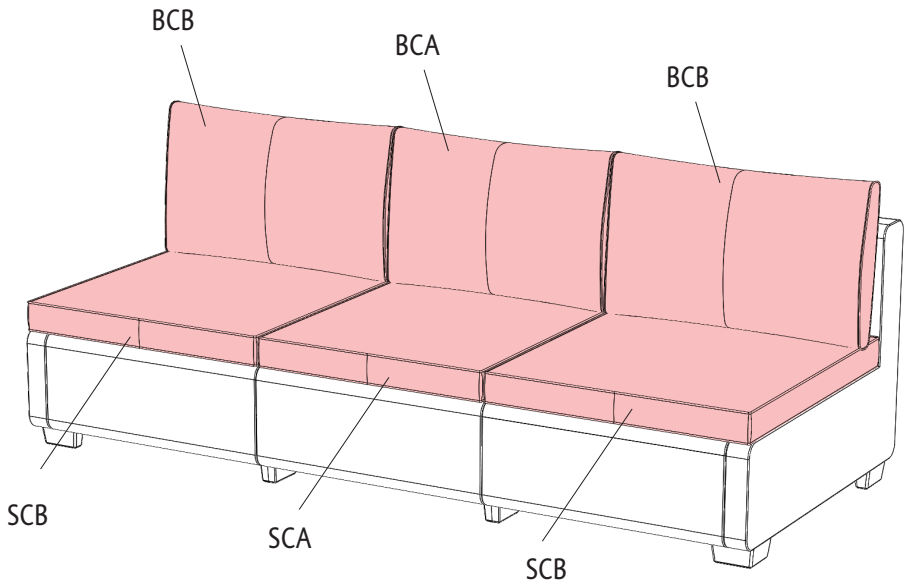

39

