

LUZON+

TABLE

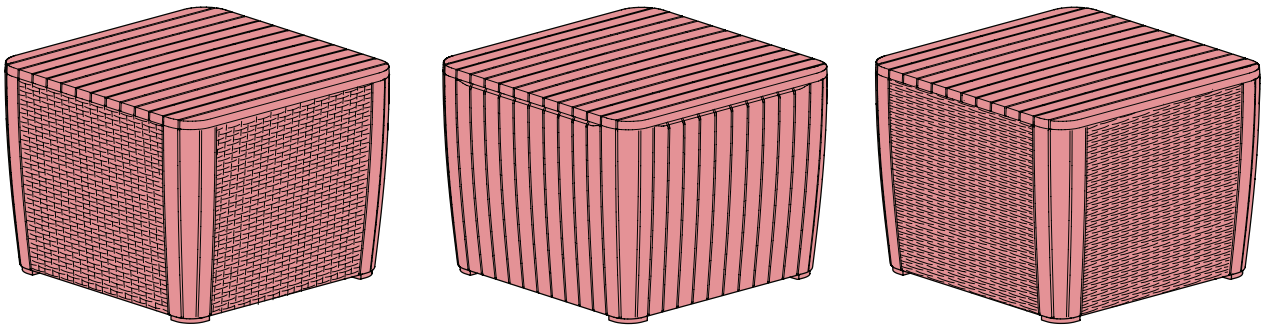

"SMALL BALCONY TABLE" V1.2 / 590982 / 442290

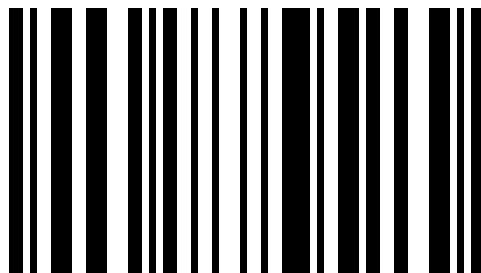

590982

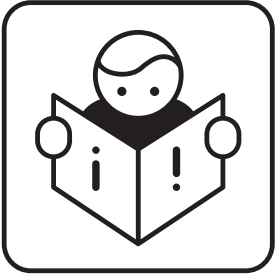

AMERICA
 EUROPE
 -Gepufte Sicherheit
 -EN581

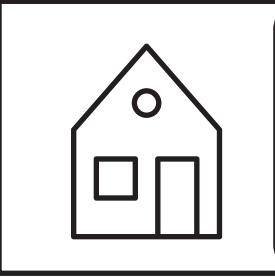

MAX 110 kg
 240 lbs

< 40 < 104
 °C °F
 > 0 > 32



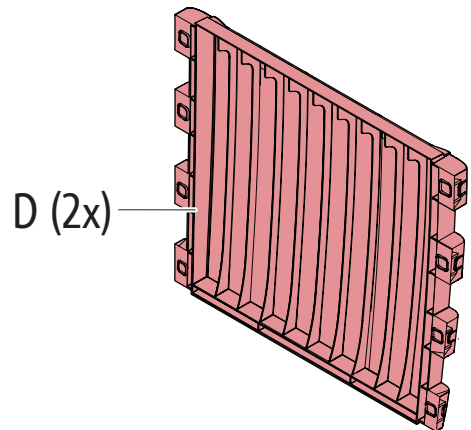
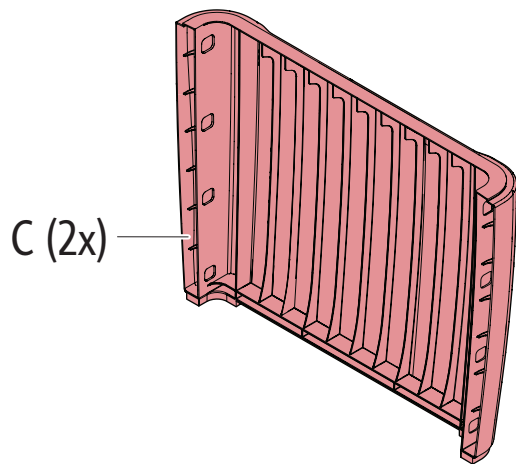
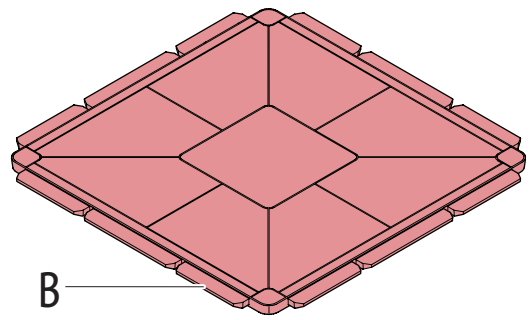
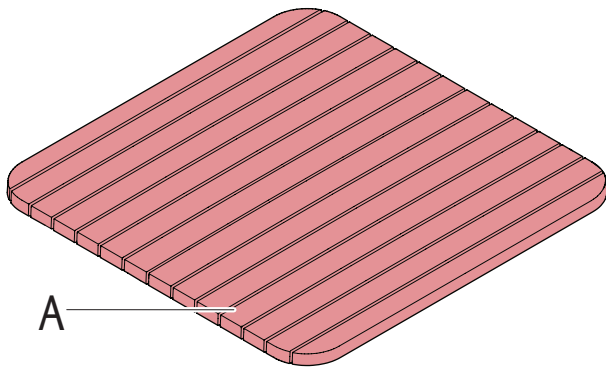

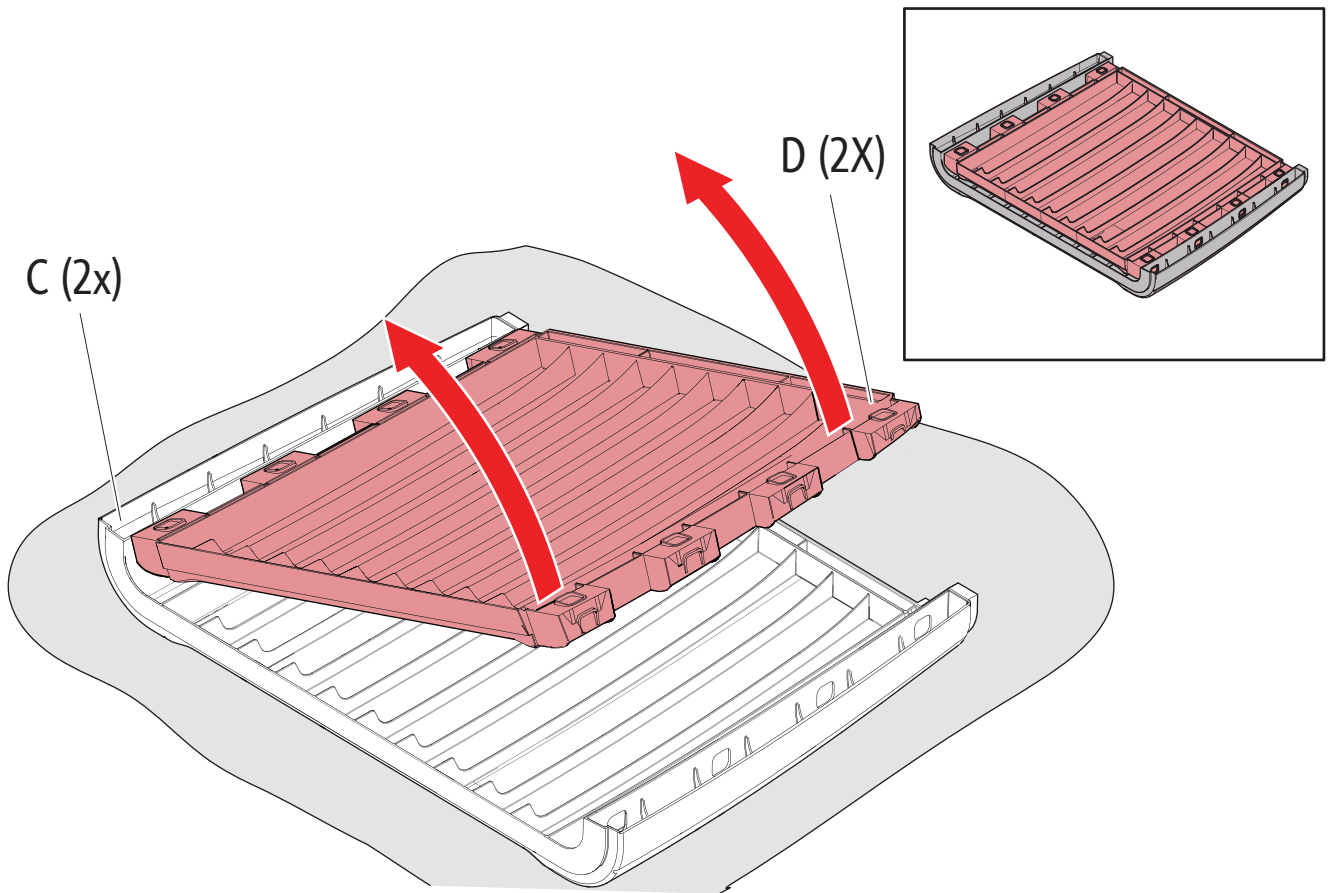

1

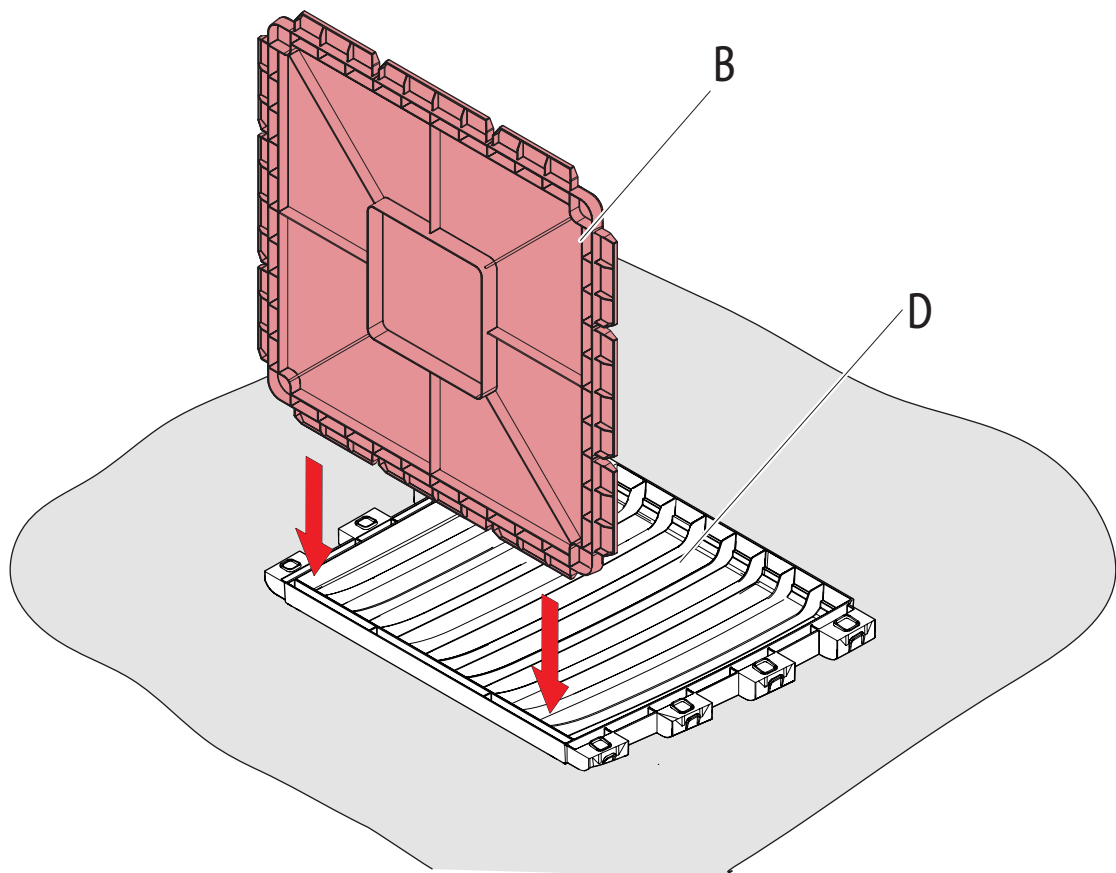

2

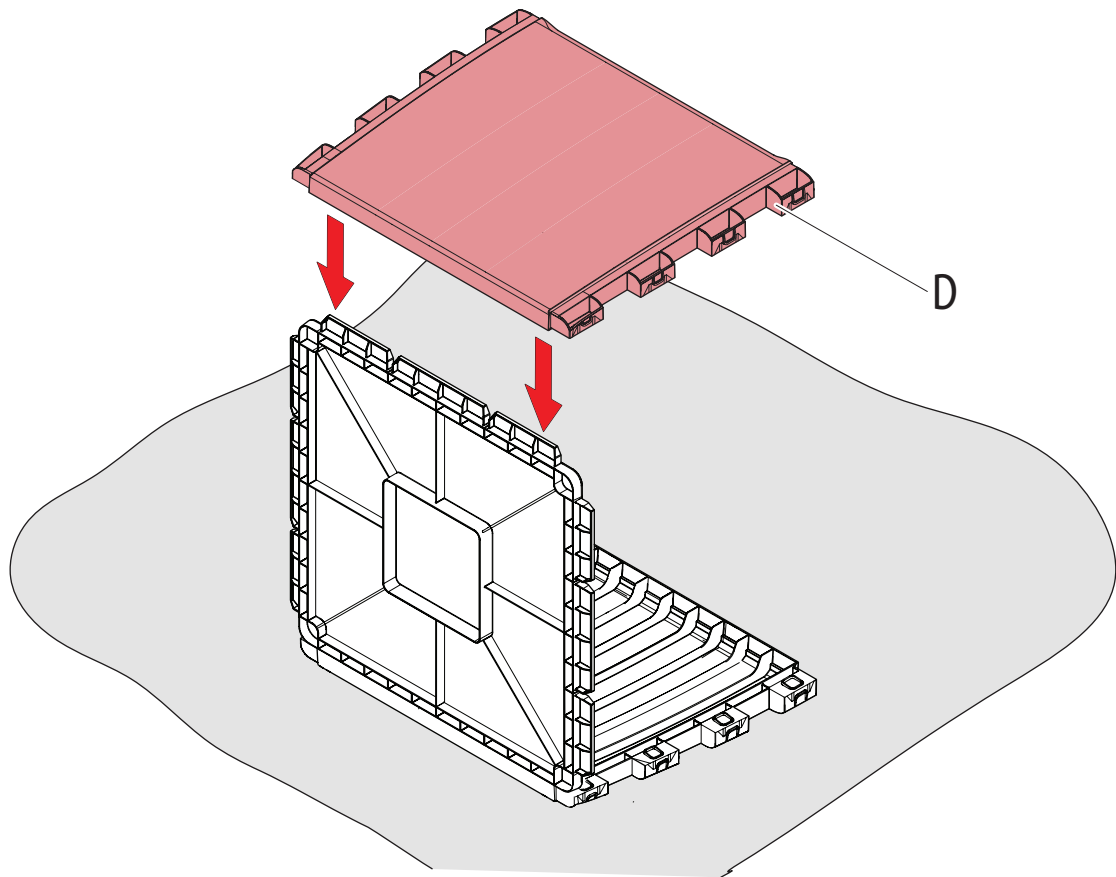

3

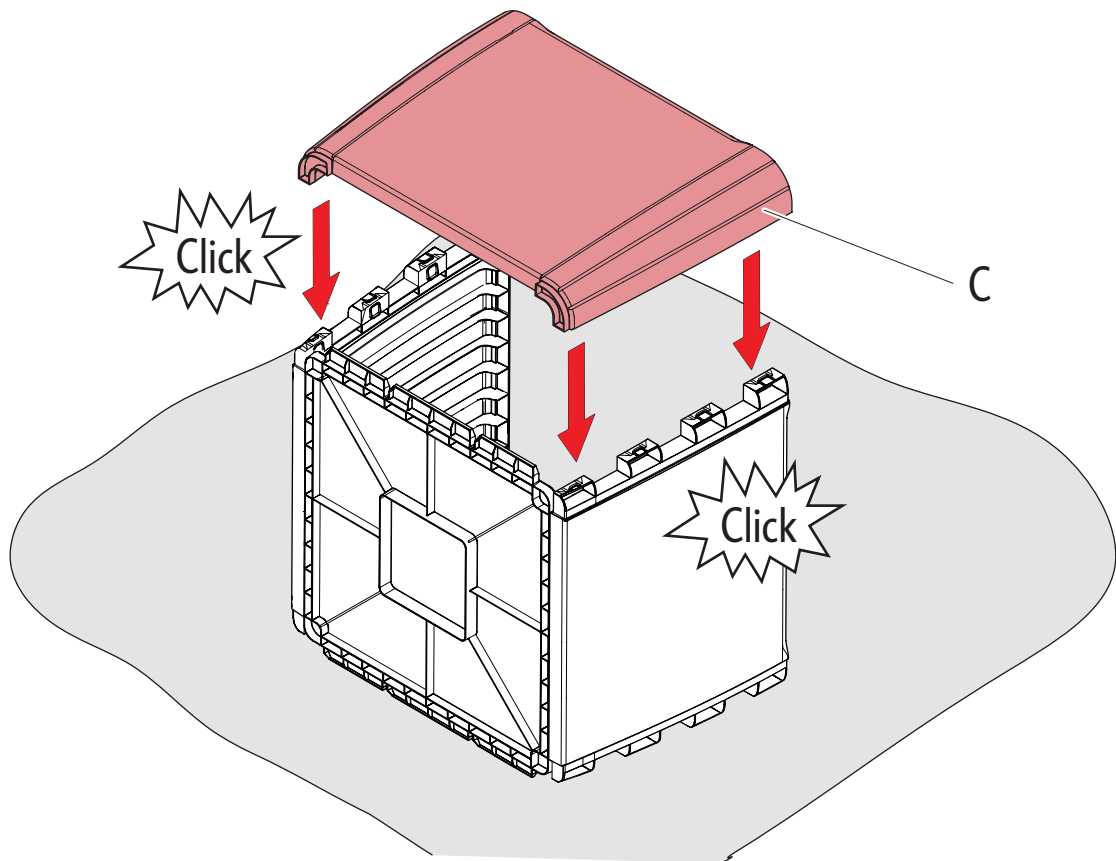

4

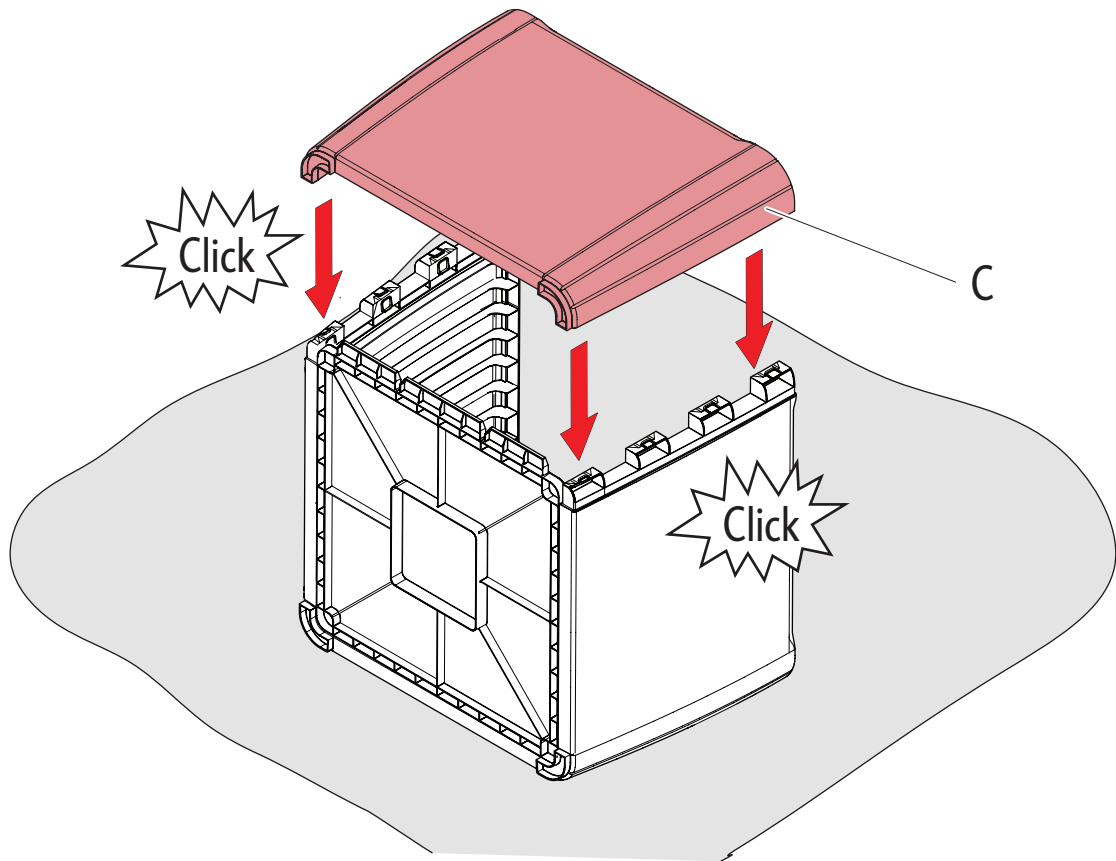

5

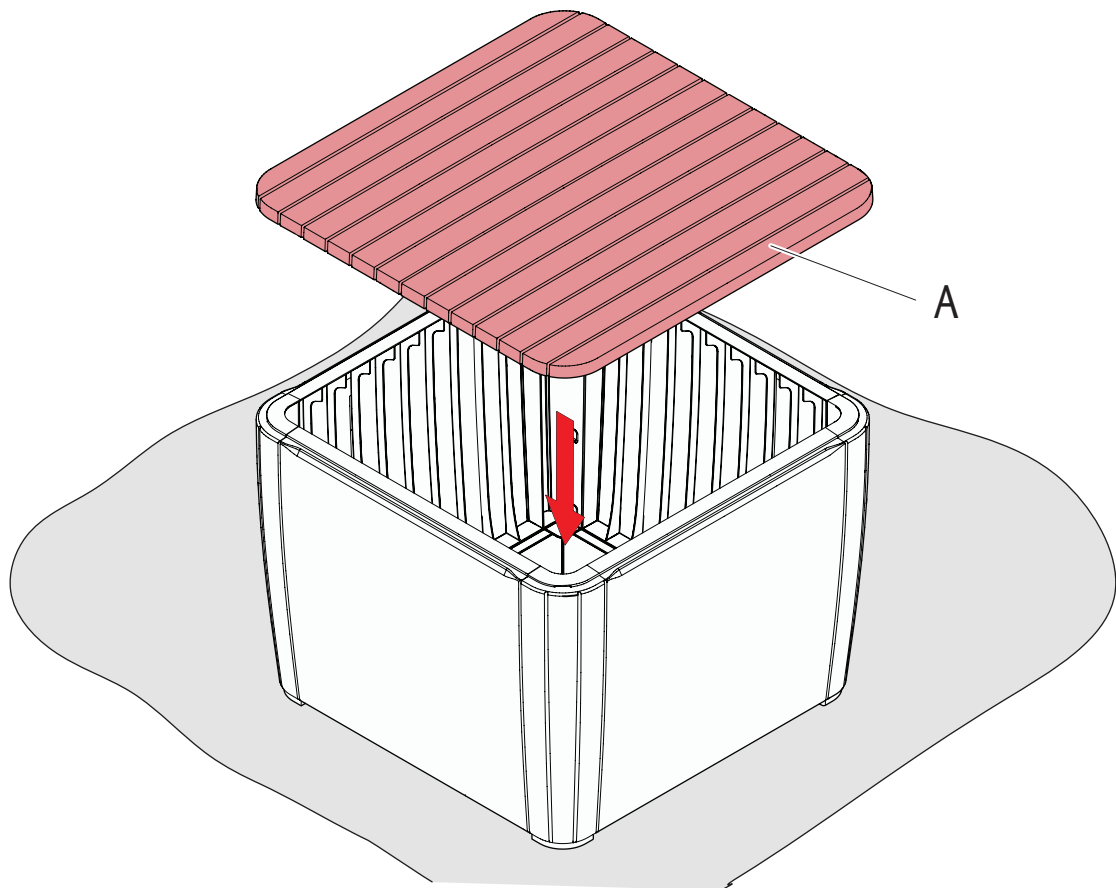

6

